

# Pinnacle Series

## Operation Manual

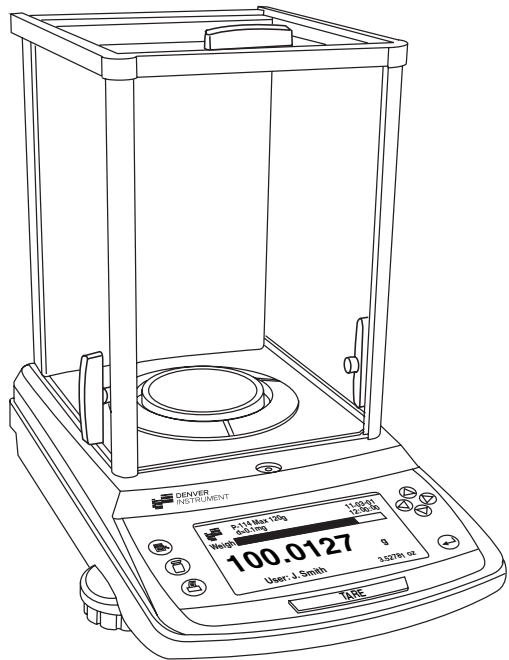

# Disclaimer

---

- Calibrate your balance using reference weights of the appropriate tolerance (class). An instrument can be no more accurate than the standard to which it has been compared. For assistance in the selection of reference weights, please contact Denver Instrument Company.
- Changes or modifications not expressly approved by the manufacturer could void the user's authority to operate this equipment.
- Use of this product in a manner not specified by the manufacturer may impair any safety protection provided by the equipment.
- Do not drop objects on the pan of the balance.
- Never lift balance by the weighing pan as this may cause damage to internal mechanism. Always lift and transport the balance by its base, including removal from packing materials.
- If load exceeds 115% of maximum capacity, damage to the balance may occur.

## Warnings and Safety Information

---

Read the entire Operation Manual prior to attempting to operate your precision balance. Connect only Denver Instrument accessories as these are designed for optimal performance.

- Make sure the voltage rating printed on the AC adapter is identical to your local line voltage.
- Do not use this balance in a hazardous location.
- The only way to turn the power completely off is by disconnecting the AC adapter from the balance.
- Protect the AC adapter from contacts with liquids.
- This product intended for indoor use.



### **WARNING!**

This unit has no user serviceable parts! Do not open the balance housing, as this will void the manufacturer's warranty.

# Table of Contents

---

<b>Specifications</b> .....	ii
<b>Introduction</b> .....	1
<b>Getting Started</b> .....	1
<b>Installation Instructions</b> .....	2
Pan Assembly .....	2
Connecting to AC Power .....	5
Leveling your balance .....	6
<b>Operation</b> .....	7
Simple weighing .....	8
Fine-Dynamic Dual-Range Balances .....	9
<b>Units</b> .....	9
Setting the weigh units .....	9
<b>Calibration</b> .....	11
<b>Counting Mode</b> .....	15
<b>Target/Percentage Weighing</b> .....	18
<b>Check Weighing</b> .....	19
<b>Formulation</b> .....	20
<b>Animal Weighing</b> .....	21
<b>Statistics</b> .....	23
<b>GLP/ISO</b> .....	25
Setting Date .....	26
Setting Time .....	76
Setting Sample ID .....	74
Setting Sample Number .....	29
<b>Print</b> .....	29
Serial Commands for Serial Interface .....	31
<b>USB</b> .....	32
<b>Ethernet</b> .....	33
<b>Environmental Settings</b> .....	35
Setting the Stability icon .....	36
Auto Zero .....	36
<b>System</b> .....	37
To set password .....	37
RS232 .....	37
To Set Bits/Parity .....	38
To Set Beep .....	39
To Set Display .....	40
<b>Standby</b> .....	40
<b>Restoring Factory Defaults</b> .....	41
<b>Menu Tree</b> .....	42
<b>Cleaning and Maintenance</b> .....	44
<b>Troubleshooting</b> .....	45
<b>Accessories</b> .....	46
<b>Warranty Instructions</b> .....	inside back cover

# Specifications

## Precision Analytical Balances

Models	P-114*	P-214*	P-314*	PI-225D
<b>Capacity</b>	110 g	210 g	310 g	60/220 g
<b>Readability</b>	0.1 mg	0.1 mg	0.1 mg	0.01/0.1 mg
<b>Taring Range</b>	0 to 110 g	0 to 210 g	0 to 310 g	0 to 60/220 g
<b>Repeatability, (s)</b>	0.1 mg	0.1 mg	0.1 mg	0.02/0.1 mg
<b>Linearity</b>	0.2 mg	0.2 mg	0.2 mg	0.03/0.2 mg
<b>Stabilization Time</b>	3 seconds	3 seconds	3 seconds	4 seconds
<b>Pan Size</b>	3.1" dia. (79mm)	3.1" dia. (79mm)	3.1" dia. (79mm)	3.1" dia. (79mm)

## Precision Toploading Balances

Models	P-203*	P-403*	P-603D*	P-402*	P-602*	P-2002*
<b>Capacity</b>	200 g	400 g	100/600 g	400 g	600 g	2000g
<b>Readability</b>	0.001 g	0.001 g	0.001/0.01g	0.01g	0.01g	0.01 g
<b>Taring Range</b>	0 to 200 g	0 to 400 g	0 to 600 g	0 to 400 g	0 to 600 g	0 to 2000g
<b>Repeatability, (s)</b>	0.001 g	0.001 g	0.002/0.01 g	0.01 g	0.01 g	0.01 g
<b>Linearity</b>	0.002 g	0.002 g	0.003/0.02 g	0.02 g	0.02 g	0.02 g
<b>Stabilization Time</b>	3 seconds	3 seconds	4 seconds	3 seconds	3 seconds	3 seconds
<b>Pan Size</b>	4.5" dia. (114mm)	4.5" dia. (114mm)	4.5" dia. (114mm)	4.5" dia. (114mm)	4.5" dia. (114mm)	7.0 x 7.0" (178 x 178mm)

Models	P-4002*	P-4002D*	P-8002D	P-6001*	P-8001
<b>Capacity</b>	4000 g	400/4000 g	800/8000 g	6000 g	8000 g
<b>Readability</b>	0.01 g	0.01/0.1 g	0.01/0.1 g	0.1 g	0.1 g
<b>Taring Range</b>	0 to 4000 g	0 to 4000 g	0 to 8000 g	0 to 6000 g	0 to 8000 g
<b>Repeatability, (s)</b>	0.01 g	0.02/0.1 g	0.02/0.1 g	0.1 g	0.1 g
<b>Linearity</b>	0.02 g	0.03/0.2 g	0.03/0.2 g	0.1 g	0.1 g
<b>Stabilization Time</b>	3 seconds	4 seconds	4 seconds	3 seconds	3 seconds
<b>Pan Size</b>	7.0 x 7.0" (178 x 178mm)	7.0 x 7.0" (178 x 178mm)	7.0 x 7.0" (178 x 178mm)	7.0 x 7.0" (178 x 178mm)	7.0 x 7.0" (178 x 178mm)

### Common Specifications

<b>Dimensions (LxWxH) Analyticals:</b>	14.6 x 9.4 x 13.3" (371 x 239 x 338mm)
<b>Dimensions (LxWxH) Toploaders:</b>	14.6 x 9.4 x 3.8" (371 x 239 x 97mm)
<b>Weighing Chamber Dimensions:</b>	8.3 x 8.0 x 9.8" (211 x 203 x 249mm)
<b>Operating Temperature:</b>	10° - 30°C (50° - 86°F)
<b>Storage Temperature:</b>	-10° - 30°C (14° - 86°F)
<b>Humidity:</b>	< 90% RH
<b>Net Weight (Analyticals):</b>	15 lbs (6.80kg)
<b>Net Weight (Toploaders):</b>	10 lbs (4.54kg)
<b>Electrical Requirements:</b>	AC: 115V 50/60Hz, other voltages available. DC: +5V 2.5A +15V 0.5A -15V 0.3A

\*PI models with internal calibration



### CAUTION!

Use AC adaptor supplied with unit only!  
Contact Denver Instrument for replacement.

# Introduction

---

Thank you for selecting a precision Denver Instrument Company balance. The Pinnacle Series is a culmination of precision weighing technology, superior user interface and highest manufacturing standards. These balances have features including:

- Efficient filtering-out of unfavorable ambient conditions such as vibrations and drafts.
- Stable and reproducible results.
- Easy to use menu operation.
- Multiple weigh units, with two displayed simultaneously.
- Rugged, durable construction for all types of environmental conditions.
- Advanced applications such as counting, percent/target weighing, animal weighing and formulation.

## Getting Started

---

### Unpacking your balance

Carefully remove your balance from the packing material. The weigh pan assembly and power transformer are removed from the balance for shipping.

Please retain all original packing material for shipment in case of repair.

Be sure that you have received each of the following items with your balance:

- Balance
- Brief Operation Manual
- Warranty Registration Card
- Round Pan (3.1" or 4.5") and Drip Ring OR Square Pan
- Power Adapter
- Power Cord
- CD including detailed operation manual, HyperTerminal templates, and USB Application

Next follow the instructions for installing your balance. To take advantage of its many features, carefully read your operating manual. It contains step-by-step procedures, examples and other vital information.

Finally, remember to return your completed warranty card within ten days and retain a record of all purchase information. Also take a moment to record the model and serial number of your balance for future reference.

# Installation Instructions

---

When choosing a location to set up your new balance, observe the following conditions to optimize ease and speed of use:

- Set up the balance on a stable, rigid and level surface.
- Avoid locations subject to extremes in heat or direct exposure to sunlight.
- Room temperatures above 86°F (30°C) or below 50°F (10°C) could affect balance operation and accuracy.
- Protect the balance from direct exposure to drafts.
- Protect the balance from aggressive chemical vapors.
- Avoid strong magnetic fields present from other devices.
- Avoid locations subject to vibration.
- Avoid exposing the balance to excessive moisture for extended periods.
- For best results, allow the balance to adjust to room temperature before connecting to power source, for at least two hours.
- Line voltage to the balance should be reasonably constant and free from fluctuations.

## **Pan Assembly**

Please observe the following precautions when handling the weighing pans:

- Do not apply manual pressure to the weighing pan at any time.
- Do not bump the pan.
- Do not drop objects onto the pan.
- Do not attempt to clean or vigorously wipe the pan while it is installed on the balance.
- When removing the pan, pull the pan straight up (pulling the pan at an angle could result in mechanical breakage).

To avoid damage to your precision balance during shipping, the pan assembly components were packed separately.

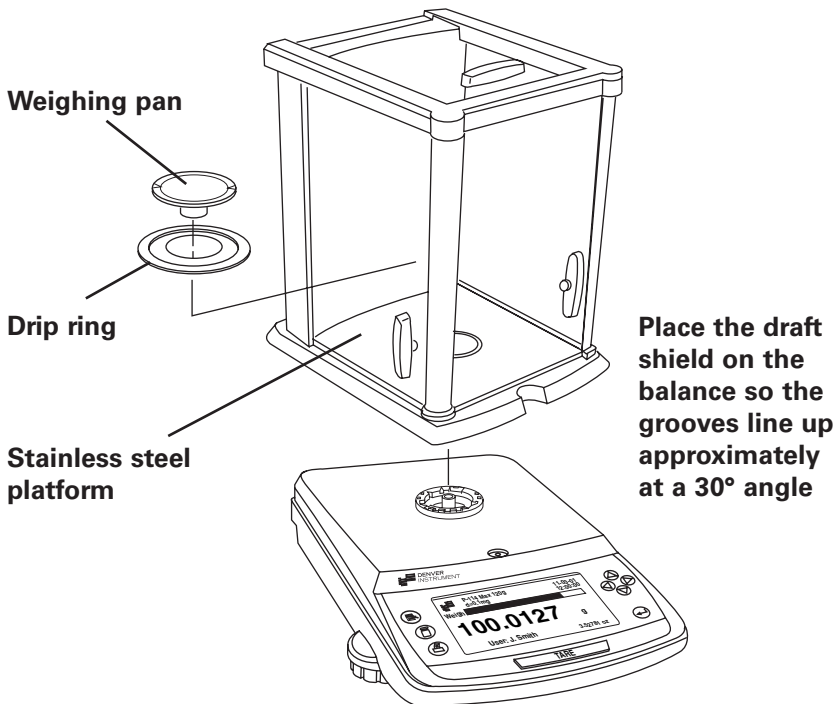

### **Analytical Balances and Draft Shield**

To attach draft shield, place it upon the balance so the grooves line up when the draft shield is approximately at a 30° angle. Pull the pin at the rear of the draft shield and turn clockwise until it is in line with the balance. Release the pin. Place the components listed below inside the chamber in the order given:

- Stainless steel platform
- Drip Ring
- Weighing Pan

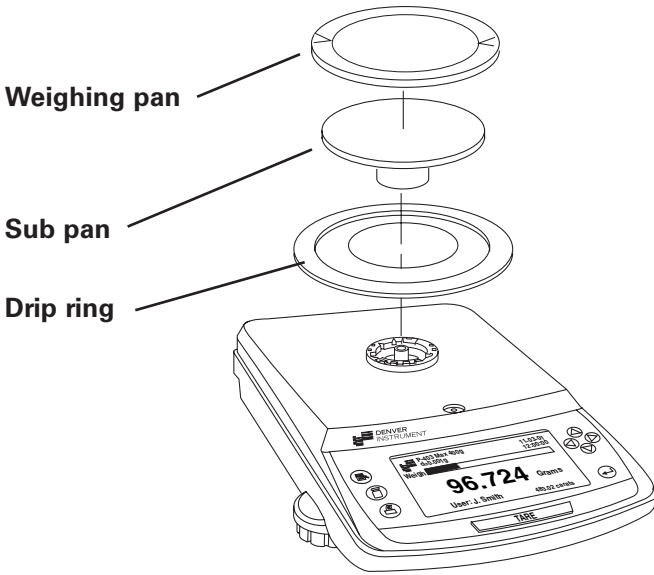

### Toploading Balances with Round Pan

Place the components listed below on the balance in the order given:

- DripRing
- Sub Pan
- Weighing Pan
- Draft Ring (Optional)
- Draft Ring Cover (Optional)

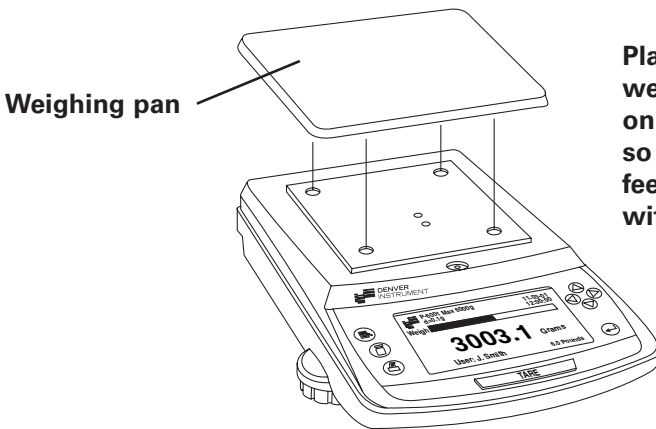

### Toploading Balances with Square Pan

- Weighing Pan

### Connecting the Balance to AC Power

When your balance has reached room temperature, simply plug the AC adapter into the rear of the balance and plug into an appropriate AC outlet. The balance will turn on automatically. For best results, the balance should be left plugged in at all times.

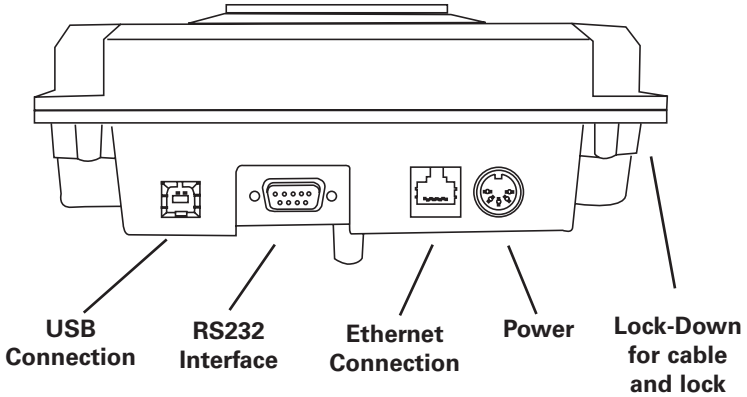

### Connecting the PI-225D to AC Power

1. Wait for balance and external electronic box to reach room temperature.
2. Attach the external electronics box to the cable on the rear of balance.
3. Plug the two-part AC adapter into the balance.
4. Plug the AC adapter into an appropriate AC wall outlet.
5. The balance will turn on automatically.
6. Wait at least 6 hours for warm-up to assure accurate results. To avoid extensive warm-up periods the balance should remain attached to the external electronic box and the box should be plugged in.

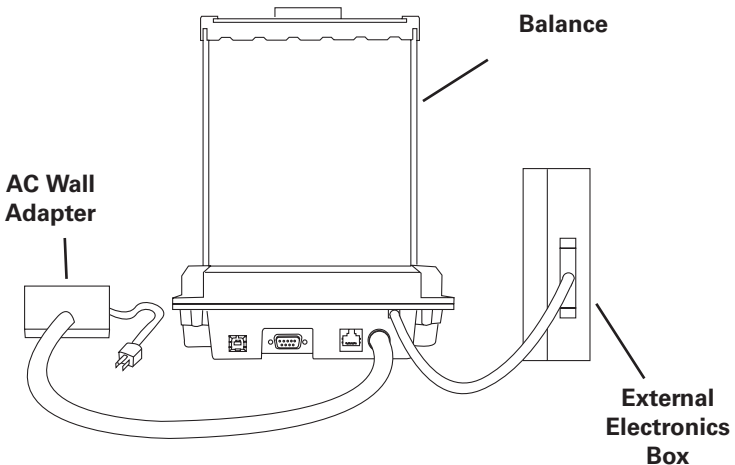



The external electronic box is powered by the balance and the box should always be attached to the balance.



Each balance has its own external electronic box. These boxes are not interchangeable.

### Leveling your Balance

It is necessary to level the balance whenever the balance is moved. Do not turn the balance over.

The number of feet varies on each model:

**Analytical models:** 2 adjustable front feet, one fixed rear foot.

**Toploading models with round pan:** 2 front feet, one rear fixed foot.

**Toploading models with square pan:** 4 adjustable feet, one in each corner.

### To level your balance:

1. Turn all leveling feet counterclockwise until the feet are fully retracted into the base of the balance.
2. Note the location of the bubble in relation to the circle. For maximum weighing accuracy, the bubble should be located inside the black ring.
3. Begin with the foot that is opposite of the location of the bubble and turn clockwise until the bubble is moved into the black ring. If necessary, repeat this step with the other leveling feet until the bubble is positioned in the center of the black ring.
4. Make sure that all feet are touching the countertop and no rocking occurs when the corners of the balance are pressed.



The bubble moves TOWARDS a foot when that foot is turned CLOCKWISE. The bubble moves AWAY from a foot when that foot is turned COUNTERCLOCKWISE.

# Operation

---

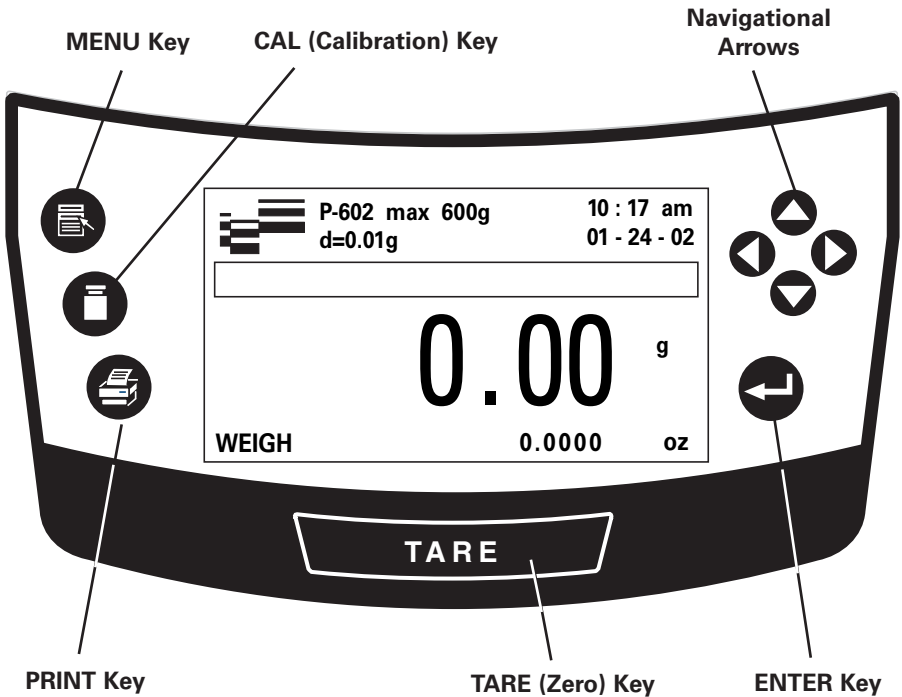

## Warm-up Time

To deliver accurate results, the balance must warm-up (be attached to AC power) for at least 2 hours (6 hours for PI-225D). Only after this time will the balance have reached the required operating temperature. It is advised to leave the unit plugged in at all times so that all components are warm and the balance is ready to weigh.

## Taring the Balance

1. Place a container on the weighing pan. The balance will register the weight of the container.
2. Press the **TARE** key.
3. The "TARING" on the screen indicates that the balance is waiting for a stable reading before taring.
4. The balance will read 0.0000 grams (or selected units to the designated resolution) after successful taring.
5. When the reading is stable, the Denver Instrument icon appears in the top, left of the display. When unstable, a "U" appears.

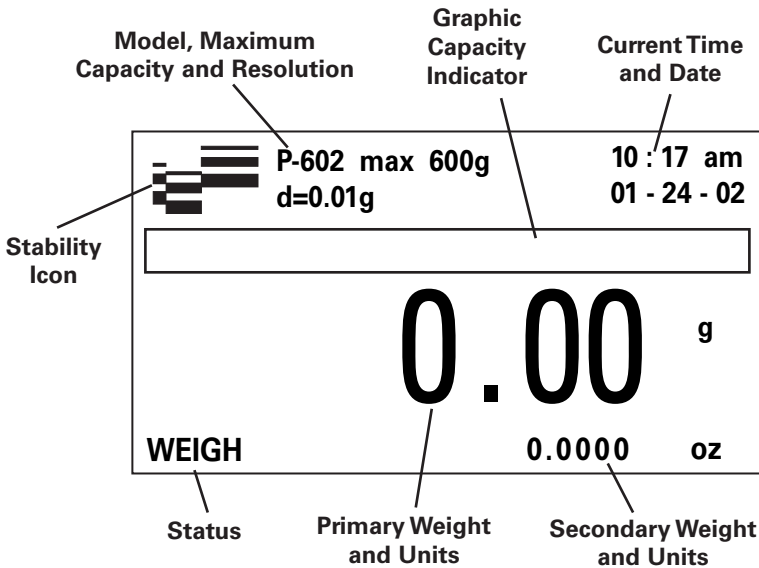

Measurement Screen

### Simple Weighing

For optimum accuracy, place your samples in the center of the weighing pan. Your balance is designed to provide accurate measurements regardless of where you place the sample on the pan; however, repeatability, accuracy and stabilization time are optimized if the load is placed as close to the center of the pan as possible.

1. Press the **TARE** key.
2. Add your sample to the center of the pan.
3. When the reading is stable, the balance displays the units of measurement as well as the Denver Instrument icon in the top, left of display.

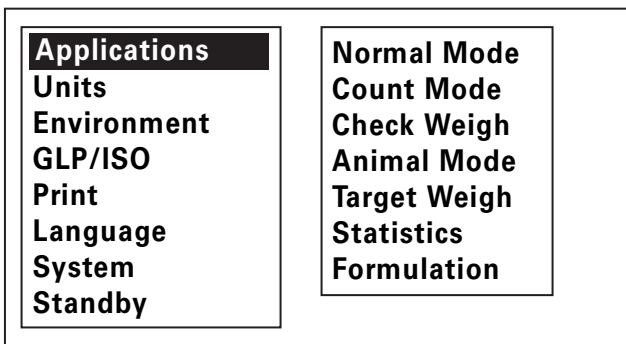

Main Menu Screen

# Fine-Dynamic Dual-Range Balances

---

Three of the Pinnacle Series Balances (P/PI-603D, P/PI-4002D and P/PI-8002D) feature fine-dynamic dual range. These balances allow you to tare along the entire weighing spectrum and measure with the highest readability of the balance. For example on a P-603D you can weigh up to 100 grams with a readability of 0.001 grams. When the reading reaches 100 grams the balance readability changes to 0.01 grams up to a total capacity of 600 grams. However if you put a beaker that weighs 153.02 grams, when you tare you get 0.001 grams readability so you can measure a sample at 15.068 grams.

## Units

---

The Pinnacle Series features 16 different weigh units. The units and their multiplication factor:

Name	Symbol	Conversion factor (1 gram = )	Unit Index
Grams	g	1.0	1
Carats	ct	5.0	9
Grains	gr	15.43235835	7
Kilograms	kg	0.001	2
Milligrams	mg	1000.0	3
Mommes	m	0.2667	13
Ounces	oz	0.035273962	4
Pennyweights	dwt	0.643014931	8
Pounds	lb	0.0022046226	6
Drams	dr	0.56438331	14
Baht	bat	0.06596306	15
Taels- Tiawan	tlt	0.02645547175	12
Tales- HK	tlh	0.02671725	10
Tales- Singapore	tls	0.02646063	11
Tola	tol	0.0857333381	16
Troy ounces	ozt	0.032150747	5

The unit index can be printed with data points. See page 29 for more information.

### Selecting Weigh Units

You can display one unit or two units simultaneously. The primary unit along with its measurement is displayed as large digits while the secondary unit and measurement is shown on the bottom right of the display.



Pressing the **TARE** key will exit from any menu without saving changes.



When selecting your units, it is necessary to scroll through several screens. To see the next screen, press the **▼** until “more” is highlighted and press **ENTER**.

**To select the primary unit:**

1. Press **MENU**.
2. Press the **▼** until “Units” is highlighted.
3. Press **▶** and the **▼** until “Primary” is highlighted.
4. Press **▶** and the **▼** until the desired primary unit is highlighted.
5. Press **ENTER** to accept and **TARE** to return to the measurement screen.

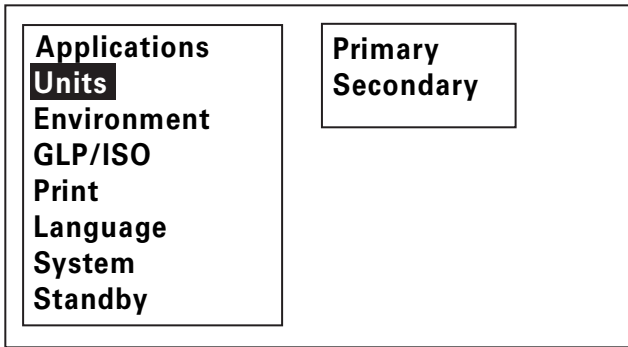

**To select the secondary unit:**

1. Press **MENU**.
2. Press the **▼** until the “Units” is highlighted.
3. Press **▶** and the **▼** until “Secondary” is highlighted.
4. Press **▶** and the **▼** until the desired secondary unit is highlighted.
5. Press **ENTER** to accept and **TARE** to return to the measurement screen or the **◀** to return to the main menu.



To disable the secondary unit, simply set the secondary unit the same as the primary unit.

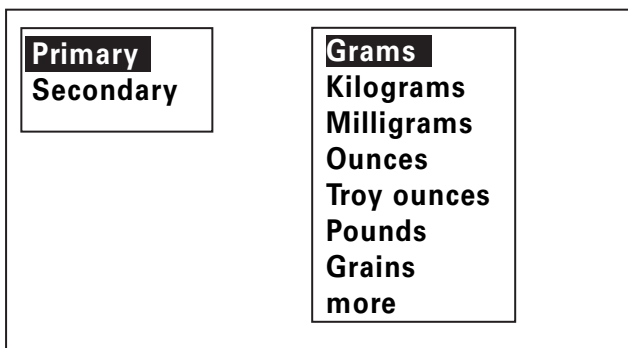

### **Toggling between Primary and Secondary Unit**

Press **ENTER** to exchange the primary and secondary units while on the measurement screen.

## **Calibration**

---

Your balance was calibrated at the factory; however, it is necessary to re-calibrate upon setup and on a regular basis thereafter. The factory recommendation for calibration is once per week using a permissible weight standard or the internal calibration (on PI models). Reasons for more frequent calibration include:

- Moving the balance
- Significant temperature changes
- Removing the balance from AC power
- Procedures to meet ISO/GLP procedures

### Recommended Calibration Weight and Class

P-114	100g	Class 1 or better
P-214	200g	Class 1 or better
P-314	200g	Class 1 or better
PI-225D	200g	Class 1 or better
P-203	200g	Class 2 or better
P-403	200g	Class 2 or better
P-603D	200g	Class 2 or better
P-402	200g	Class 4 or better
P-602	500g	Class 4 or better
P-2002	2kg	Class 2 or better
P-4002	2kg	Class 2 or better
P-4002D	2kg	Class 2 or better
P-8002D	5kg	Class 1 or better
P-6001	5kg	Class 3 or better
P-8001	5kg	Class 3 or better



Note:

For the PI-225D calibration should be performed in the range most commonly weighed in. If measurements are taken from 0 to 60 grams, calibrate the 0.1mg range with a 50 gram, Class 1 or better weight. If measurements are taken across the entire weighing spectrum calibrate with a 200 gram, Class 1 or better weight.



Note:

Other external calibration weights can be used for calibration. You should always calibrate at the maximum weight typically measured.

### External Calibration Procedure

1. Remove all items from the balance.
2. Press **TARE**.
3. Gently place the weight in the center of the pan.
4. Press the Calibration softkey.
5. The unit will display "CAL External" and the calibration weight.
6. When calibration is complete the reading of the weight will be displayed and the unit will return to measurement mode.



Note:

Error messages will be displayed if calibration cannot be completed. See Troubleshooting Guide for more information.

### Internal Calibration Procedure (PI Series only)

1. Remove all items from the balance.
2. Press **TARE**.
3. Press the Calibration softkey.
4. "CAL Internal" will be displayed during calibration.
5. When calibration is complete the unit will return to measurement mode.



To perform external calibration, place appropriate weight on balance before pressing the calibration softkey

### DenverCal (PI Series Only)

DenverCal ensures that your balance is always in calibration based on manufacturer or your company's requirements. When Automatic mode is selected the balance will perform an internal calibration when a significant temperature change has occurred or a factory-defined time has passed. When the Interval is set the balance will perform an internal calibration based on the number of days defined in the menu.

When the DenverCal conditions are met, a "C" will flash with the stability icon. If there is no weight on the pan and no balance activity detected for 120 seconds the balance will display "DenverCal" and countdown from 15. An internal calibration will then be completed. After the internal calibration has been completed the balance will wait for the DenverCal conditions to be met again and repeat this process.



If the "C" is flashing and you do not want to wait for the countdown, you can perform an internal calibration by following the "Internal Calibration Procedure" on page 12.









To stop internal calibration during 15 second countdown, press the TARE key. The balance will wait until no balance activity has occurred for 120 seconds.









### Automatic Mode Conditions

Model	Time (hrs.)	Temperature (°C)
PI-114	4	1.5
PI-214	4	1.5
PI-314	4	1.5
PI-225D	4	1.5
PI-203	12	4
PI-403	12	4
PI-603D	24	4
PI-402	24	4
PI-602	24	4
PI-2002	12	4
PI-4002	12	4
PI-4002D	12	4
PI-6001	24	4







### To turn DenverCal Automatic Mode On/Off:

1. Press **MENU**.
2. Press the  until "System" is highlighted, press the .
3. Press the  until "DenverCal" is highlighted, press the .
4. Press the  until "Automatic" is highlighted, press **ENTER**.
5. Press the **TARE** key to return to the measurement screen or  to return to the main menu.

### To set DenverCal Interval:

1. Press **MENU**.
2. Press the  until "System" is highlighted, press the .
3. Press the  until "DenverCal" is highlighted, press the .
4. Press the  until "Interval" is highlighted, press the .
5. Press the  or the  until desired interval time (in days, 1 to 180) is displayed, press **ENTER**.
6. Press the **TARE** key to return to the measurement screen or  to return to the main menu.

### To turn DenverCal Off:

1. Press **MENU**.
2. Press the  until "System" is highlighted, press the .
3. Press the  until "DenverCal" is highlighted, press the .
4. Press the  until "Off" is highlighted, press **ENTER**.
5. Press the **TARE** key to return to the measurement screen or  to return to the main menu.



#### Note:

When DenverCal is "Off", calibration will only be completed if the calibration key is pressed.

# Counting Mode

---

In counting mode, you can determine the number of parts, each having approximately the same weight. A reference weight is determined for the reference quantity and the balance weighs and counts similar pieces.

The balance will display both the piece count and the combined weight in units set as the primary units.



Pressing the **TARE** key will exit from any menu without saving changes.



The total sample weight must not exceed the balance capacity.



The weight of each piece must be greater than the resolution of the balance.

## Entering count mode:

1. Press **MENU**.
2. When “Applications” is highlighted, press the **▶**.
3. Press **▼** until “Count Mode” is highlighted, then press the **▶**.
4. Using the **▼** and **▲** selected the desired reference quantity (5, 10, 20, 50 or 100 or custom).
5. Press the **ENTER** key to accept and begin count mode.

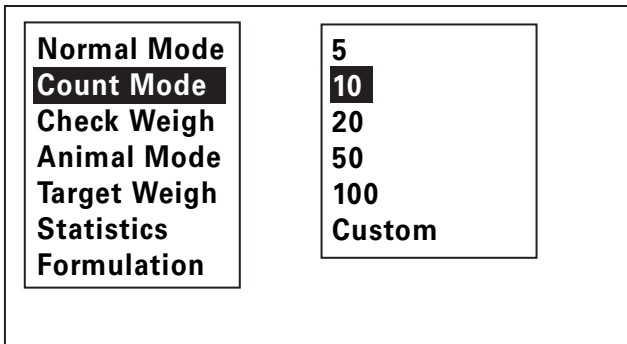

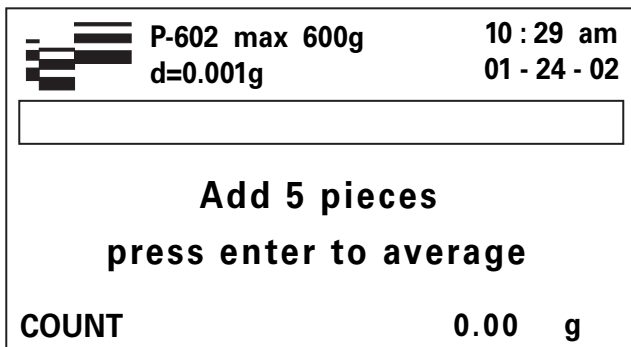

**Beginning to count:**



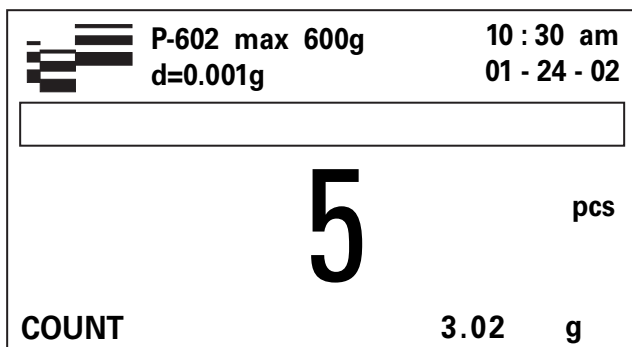

1. Remove all items from the pan, except a container if necessary.
2. Follow steps of "Entering count mode".
3. Place the number of pieces equal to the reference quantity on the balance.
4. Press **ENTER** and the balance will automatically calculate the piece weight and store it as the reference weight.
5. Add uncounted parts. A total number of pieces as well as the combined weight is displayed.
6. Taring the balance will change the piece count to zero.











### To change the reference weight:

1. Remove all items from the pan, except a container if necessary.
2. Press **TARE**.
3. Press **ENTER** and place the number of pieces equal to the reference quantity on the balance and press **ENTER**.

### To change the reference quantity:

1. Press **MENU**.
2. When "Applications" is highlighted, press the .
3. Press the  key until "Count Mode" is highlighted and press the .
4. Press the  or  key until the desired reference quantity is selected. Options are 5, 10, 20, 50, or 100 or custom.
5. Press the **ENTER** key to accept and begin counting mode.

### To set custom reference quantity:

1. Press **MENU**.
2. When "Applications" is highlighted, press the .
3. Press the  key until "Count Mode" is highlighted and press the .
4. Press the  or  key until "Custom" is highlighted, then press .
5. Using the  or  key, set the first digit of the custom quantity. Press  to move to the next digit.
6. When the number is set, press **ENTER** to accept and begin count mode.



Pressing **PRINT** will send the piece count through RS232.



To quit Count Mode, select "Normal Mode" in application menu.

# Target/Percent Weighing Mode

---

This application allows you to obtain weight readout in percent proportional to a reference weight. You can also set limits for the reading with plain-language limit values.

The balance will display both the percentage and the total weight in units set as the primary units.



Pressing the **TARE** key will exit from any menu without saving changes.



The total sample weight must not exceed the balance capacity.

## Entering target mode:

1. Press **MENU**.
2. When "Applications" is highlighted, press the **▶**.
3. Press the **◀** until "Target Weigh" is highlighted and then press **▶**.
4. Enter the Target weight:
  - a. Using the **▶** move the cursor to the correct digit, in relationship to the decimal place to be changed.
  - b. Press **◀** or **▶** until the desired unit is selected.
  - c. Press **▶** to move to the next digit.
  - d. Repeat these steps until the correct target weight (in units selected as primary) is displayed.
  - e. Press **ENTER**.

## Beginning to percent weighing:

1. "Target Weigh" should be displayed on screen. If not follow steps to "entering target mode".
2. Remove all items from the pan, except a container if necessary.
3. Press the **TARE** key.
4. Add or subtract parts and a percentage of the weight as well as the combined weight is displayed.
5. Taring the balance will change the percentage to zero.



Pressing **PRINT** will send the percentage along with weight (in selected print format) to RS232.



To quit Target Mode, select "Normal Mode" in application menu.

# Check Weighing Mode

---

This application allows you to obtain plain-language limit responses to your weight based off of limits which are defined by the user.



Pressing the **TARE** key will exit from any menu without saving changes.

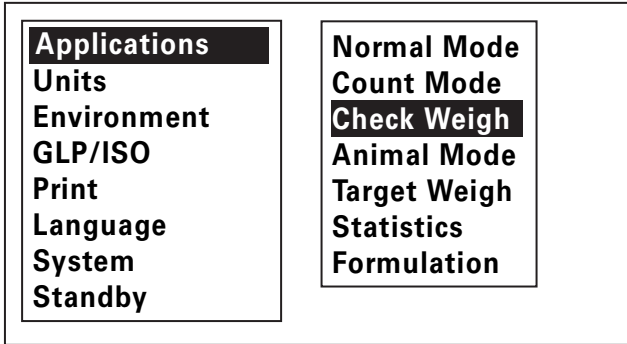

Check Weighing Screen

## Setting target high and low limits:

Use this feature to receive an "OK" when the reading is within user defined limits. "HIGH" or "LOW" message are displayed when the reading is outside of these limits.

1. Press **MENU**.
2. When "Applications" is highlighted, press the **▶**.
3. Press the **▼** until "Check Weigh" is highlighted and then press **▶**.
4. Press the **▲** or **▼** key until "High Limit" (or "Low Limit") is displayed, press **▶**.
5. Enter the weight where outside of this the value you receive a "High" (or "Low") target message.
  - a. Using the **▶** move the cursor to the correct digit, in relationship to the decimal place to be changed.
  - b. Press **▲** or **▼** until the desired unit is selected.
  - c. Press **▶** to move to the next digit.
  - d. Repeat these steps until the limit is displayed.
  - e. Press **ENTER**.
6. Using the same procedure, set the other limit.
7. Press **▼** until "Enable" is highlighted.
8. Press the **ENTER** key to accept and return to the measurement screen.
9. Taring will change the weight to zero.



Note:

To quit Check weighing, select “Normal Mode” in application menu.

## Formulation

---

This feature allows you to weigh out several different components in one container. The weight of the individual component will be shown as well as the total weight.



Note:

Pressing the **TARE** key will begin a new formulation without storing current weight.



Note:

The total weight on the pan may not exceed the maximum capacity of the balance.

### Entering formulation mode:

1. Press **MENU**.
2. When “Applications” is highlighted, press the **▶** key.
3. Press **▼** until “Formulation” is highlighted, then press **ENTER**.

### Beginning a formulation:

1. “Formulation” should be displayed on the screen. If not, follow steps in “entering formulation mode”.
2. Place the container on the pan.
3. Press the **TARE** key.
4. Place the first component in the container and press **ENTER**. This measurement is now stored.
5. Add the second component. The weight of this component is displayed as the primary measurement and the cumulative weight as the secondary measurement.
6. Repeat above step for all components.
7. When finished, press the **TARE** key. The cumulative weight plus each individual weight will be sent to RS232. Formulation data will be cleared.



Note:

Pressing **PRINT** will send the cumulative weight to RS232.



Note:

At any time, toggle of component and total weight is possible with the **▼** or **▲** keys.



Note:

To quit Formulation mode, select “Normal Mode” in applications menu.

## Animal Weighing

---

Animal weigh mode makes it easy to weigh animals that are continuously moving as the weight is taken. This feature can also be used for measurements taken in environments with extreme vibrations and/or drafts.









**There are two start settings.**

**Automatic** - the count begins automatically when a weight is placed on the pan.

**Manual** - press the enter key to begin the countdown.

You can also define the number of points to average (5, 10, 15 or 20). The higher the number of points selected, the more accurate the results but the test time increases.

**Entering animal weighing mode:**

1. Press **MENU**.
2. When “Applications” is highlighted, press the .
3. Press  until “Animal Mode” is highlighted and then press .
4. Press the  or  key to select start parameter and then press .
5. Press  or  to select number of point to average.
6. Press the **ENTER** key to return to the measurement screen or  to return to the main menu.

**Beginning animal weighing:**

1. “Animal” should be displayed on screen. If not follow steps to “Entering animal weighing mode”.
2. Remove all items from the pan, except a container if necessary.
3. Press the **TARE** key.
4. Place animal or sample on the balance.
5. Press **ENTER** (for manual start) and the balance will automatically begin the countdown.
6. When the number of values to average is met, “**LOCKED**” will be displayed along with the average value. A “L” will also appear as the stability icon.
7. To Unlock the reading, remove the animal/sample from the pan or press **ENTER**.
8. Repeat steps 2-7 for all samples.



Note:

Pressing **PRINT** while value is “LOCKED” will send reading to RS232.

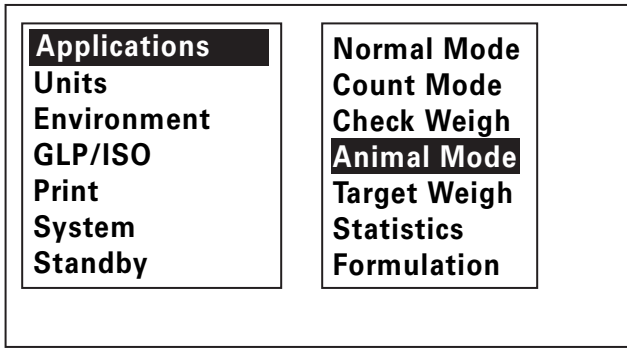

Animal Weighing Screen

**To adjust the start setting or number of points to average:**

1. Press **MENU**.
2. When "Applications" is highlighted, press the **▶**.
3. Press **▼** until "Animal Mode" is highlighted and then press **▶**.
4. Press the **▲** or **▼** key until "Automatic" or "Manual" is displayed, press **▶**.
5. Press the **▲** or **▼** key until the desired number of points to average is highlighted.
6. Press the **ENTER** key to return to the measurement screen or **◀** to return to the main menu.



**Note:** To quit Animal Mode, select "Normal Mode" in applications menu.



**Note:** Pressing the **TARE** button during avergaing will stop the averaging process and tare the balance.

# Statistics

---

Your balance has an internal memory of 250 data points. You can calculate and print statistics including: number of points, minimum weight, maximum weight, range, average, standard deviation and total weight.

## Entering statistics mode:

1. Press **MENU**.
2. Press **▶** when "Applications" is highlighted.
3. Press **▲** until "Statistics" is highlighted, press the **▶**.
4. Press the **▲** or **▼** key until "Enable" is displayed.
5. Press the **ENTER** key to return to the measurement screen or **◀** to return to the main menu.

## To store a point for statistics:

1. "Statistics" should be displayed on screen. If not follow steps for "Entering statistics mode".
2. Press **PRINT** and the point will be sent as output and also stored in the statistics memory.

## To print data log:

1. Press **MENU**.
2. Press **▶** when "Applications" is highlighted.
3. Press **▲** until "Statistics" is highlighted, press the **▶**.
4. Press the **▲** or **▼** key until "Print" is displayed.
5. Press the **ENTER** key to print and return to the measurement screen.

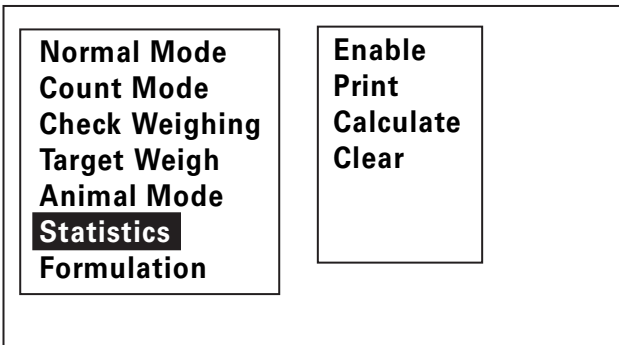

The weight value, weight unit, time, date and statistical number is the only information stored in the data log.

### To display and print statistics:

1. Press **MENU**.
2. Press **▶** when “Applications” is highlighted.
3. Press **▼** until “Statistics” is highlighted, then press **▶**.
4. Press the **▼** or **▲** key until “Calculate” is displayed, then press **ENTER**. Statistical results are now displayed on the screen.
5. To print, press the **PRINT** key.
6. Press the **ENTER** key to return to the measurement screen.

### To clear data log and statistics:

1. Press **MENU**.
2. Press **▼** until “Statistics” is highlighted, press the **▶**.
3. Press the **▼** or **▲** key until “Clear” is displayed.
4. Press the **ENTER** key to clear points and return to the measurement screen.



To exit Statistics, select “Normal Mode” in Applications menu.

# GLP/ISO

---

Your balance has a number of features that will allow customization for various reporting requirements pertaining to GLP and ISO requirements. When the header is on, GLP/ISO information will print with every data point.

## Setting User Identification:

The user identification can be up to 9 alphanumeric characters.

1. Press **MENU**.
2. Press  $\blacktriangledown$  until "GLP/ISO" is highlighted, press the  $\blacktriangleright$ .
3. Press the  $\blacktriangle$  or  $\blacktriangledown$  key until "User" is highlighted, then press  $\blacktriangleright$ .
4. Enter the user ID.
  - a. Press  $\blacktriangle$  or  $\blacktriangledown$  until the desired character is selected.
  - b. Press  $\blacktriangleright$  to move to the next character.
  - c. Repeat these steps until the user ID is displayed.
  - d. Press **ENTER**.
5. Press the **TARE** key to return to the measurement screen or  $\blacktriangleleft$  to return to the main menu.



Note:

GLP/ISO Header must be "On" to print User ID.

Applications	User
Units	Date
Environment	Time
<b>GLP/ISO</b>	Sample ID
Print	Number
Language	Header
System	
Standby	

### Setting the Date:

1. Press **MENU**.
2. Press  $\blacktriangledown$  until "GLP/ISO" is highlighted, press the  $\blacktriangleright$ .
3. Press the  $\blacktriangledown$  until "Date" is highlighted, press the  $\blacktriangleright$ .
4. Select the desired format, MM/DD/YY or DD/MM/YY, where MM=month, DD=Day, and YY=Year, and press the  $\blacktriangleright$ .
5. Enter the date.
  - a. Press  $\blacktriangle$  or  $\blacktriangledown$  until the desired digit is selected.
  - b. Press  $\blacktriangleright$  to move to the next digit.
  - c. Repeat these steps until the correct date is displayed.
  - d. Press **ENTER**.
6. Press the **TARE** key to return to the measurement screen or  $\blacktriangleleft$  to return to the main menu.

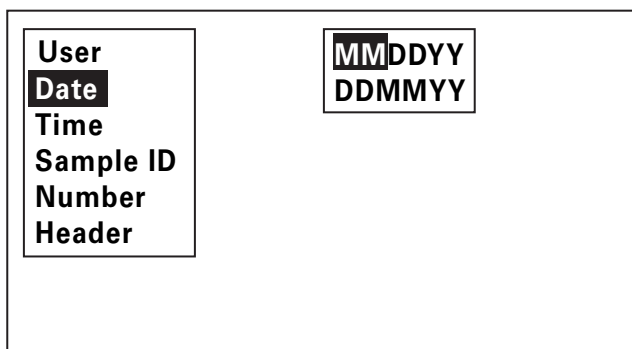









### Setting the Time (HH : MM):

1. Press **MENU**.
2. Press  $\blacktriangledown$  until "GLP/ISO" is highlighted, press the  $\blacktriangleright$ .
3. Press the  $\blacktriangledown$  until "Time" is highlighted, press the  $\blacktriangleright$ .
4. Press  $\blacktriangle$  or  $\blacktriangledown$  to select either 12 hour or 24 hour and then press the  $\blacktriangleright$ .
5. Enter the time.
  - a. Press  $\blacktriangle$  or  $\blacktriangledown$  until the desired digit is selected.
  - b. Press  $\blacktriangleright$  to move to the next digit.
  - c. Repeat these steps until the correct time is displayed.
  - d. Press **ENTER**.
6. Press the **TARE** key to return to the measurement screen or  $\blacktriangleleft$  to return to the main menu.

### Setting the Sample ID:

The Sample ID can be up to 9 alphanumeric characters. This is ideal for batch weighing.

1. Press **MENU**.
2. Press  until "GLP/ISO" is highlighted, press the .
3. Press the  until "Sample ID" is highlighted, press the .
4. Enter the sample ID.
  - a. Press  or  until the desired character is selected.
  - b. Press  to move to the next character.
  - c. Repeat these steps until the desired ID is displayed.
  - d. Press **ENTER**.
5. Press the **TARE** key to return to the measurement screen or  to return to the main menu.











**Note:**

GLP/ISO Header must be "On" to print Sample ID.

### Setting the Sample Number:

The Sample Number can be started at any point from 0 to 999999999. This number can be printed along with each data point and is automatically increased by one each time the print key is pressed.

1. Press **MENU**.
2. Press  until "GLP/ISO" is highlighted, press the .
3. Press the  until "Number" is highlighted, press the .
4. Enter the starting sample number.
  - a. Press  or  until the desired digit is selected.
  - b. Press  to move to the next digit.
  - c. Repeat these steps until the starting sample number (up to 999999999) is displayed.
  - d. Press **ENTER**.
5. Press the **TARE** key to return to the measurement screen or  to return to the main menu.



**Note:**









GLP/ISO Header be "On" to print Sample Number.

## Printing ISO/GLP Header

If selected "On", a header will be printed which includes: balance model, serial number, user ID, time, date, sample ID, and sample number with each data point.

### Print-out Sample

```
-----  
model   PI-214 _____ balance model  
balance PI214054006 _____ balance serial number  
sample  25 _____ sample number  
09-17-04 _____ date  
15:59 _____ time  
ANNA 1ST _____ user ID  
OATMEAL _____ sample ID  
U +      6.2471 GRAMS _____ result (in selected print format)  
-----
```

1. Press **MENU**.
2. Press  until "GLP/ISO" is highlighted, press the .
3. Press the  until "Header" is highlighted, press the .
4. Press  or  until the desired setting is selected and press **ENTER**.
5. Press the **TARE** key or  to return to the measurement screen, or  to return to the main menu.

# Print







---

This balance has a bi-directional RS232 port which enables communication with other serial devices such as a printer or computer. For more information concerning the RS232 port see "RS232" under "System".

## Setting print mode:

You can set the print condition according to your data output needs:

- Manual - upon pressing **PRINT**
- Stable - each time the balance reaches a stable point.
- Interval - upon user-set interval

1. Press **MENU**.
2. Press  until "Print" is highlighted, press the .
3. Press the  until "Mode" is highlighted, press the .
4. Press the  or  arrow until the desired print condition is highlighted.
5. Press the **ENTER** key to accept and the **TARE** key to return to the measurement screen or  to return to the main menu.

 **Note:** Internal print setting provides active reading only during applications.

## Setting format type:

You can adjust the output of the data string to one of the following formats:

### SAMPLE OUTPUT CHART

Output can be in one of the following formats:







Type	Stable	Unstable
Type 1	1 + 100.0001	U + 100.0001
	1 + 0.0001	U + 0.0001
Type 2	S + 100.0002	SD + 100.0002
	S + 0.0002	SD + 0.0002
Type 3	ST + 100.0001	US + 100.0003
	ST + 0.0001	US + 0.0003
Type 4	+ 100.0003	+ 100.0002
	+ 0.0003	+ 0.0002
Type 5	+ 100.0002 GRAMS	+ 100.0002 US
	+ 0.0002 GRAMS	+ 0.0002 US
Type 6	+ 100.0002 GRAMS	+ 100.0001 GRAMS
	+ 0.0002 GRAMS	+ 0.0001 GRAMS
Type 7	1 + 100.0002 g	U + 100.0003 GRAMS
	1 + 0.0002 g	U + 0.0003 GRAMS
Type 8	1 + 00100.0002	U + 00100.0002
	1 + 0000.0002	U + 0000.0002



Where “1” is the unit index number (see page 9 for list).



Actual output may vary decimal places depending on model.

1. Press **MENU**.
2. Press  until “Print” is highlighted, press the .
3. Press the  until “Format” is highlighted, press the .
4. Press the  or  arrow until the desired output type is highlighted, and press **ENTER**.
5. Press the **TARE** key to return to the measurement screen, or  to return to the main menu.

## Serial Commands for Serial Input

You can connect a computer to your balance to send commands via the balance RS232 interface port to control balance functions and operations. All commands are followed with a CR/LF:

To set or get autozero sensitivity

"SET AS ON" or "GET AS OFF"  
"GET AS"

To calibrate

"DO CAL" or "DO CE"

To set or get current environmental filter length

"SET FL LOW", "SET FL NORMAL" or "SET FL HIGH"  
"GET FL"

To print current measurement

"DO PR"

To Tare

"DO T" or "DO Z" or "Z" without CR/LF

To set or get time in 24 hour mode settings

"GET TT"  
"SET TT HH/MM/SS"  
where H is hour, M is minute and S is seconds

To get calibration data

"GET CA"

To set echo:

"SET SE ON" or "SET SE OFF"

To get or set stability speed

"SET SP FAST", "SET SP NORMAL " or "SET SP SLOW"  
"GET SP"

To get or set stability sensitivity

"SET SS VERY\_COARSE", "SET SS COARSE", "SET SS NORMAL" or "SET SS FINE"  
"GET SS"

To get or set date

"GET MM XX-DD-YY" where XX is month, DD is date and YY is year

To get software version

"GET SV"

To set print mode:

"SET PM INTERVAL" and "SET PI VV" where VV is time in seconds  
"SET PM MANUAL"  
"SET PM STABLE"

To cset weigh units:

"F0" for grams  
"F2" for pennyweight  
"F3" for ounces  
"F4" for troy ounces  
"F5" for grains  
"F6" for carat  
"F7" for pound  
"FA" for kilograms

# USB

---

Your Pinnacle Series balance is equipped with a Universal Serial Bus (USB) port. USB can be used to exchange and transmit data from the balance and a computer. Denver Instrument is also providing a USB application that allows you to see the balance measurements on the screen, view internal print information and/or store measurements. We have designed the data collection portion of this USB application to save data in a text file or in an Excel workbook.

## **Compatible Operating Systems:**

Denver Instrument's USB Application works with Microsoft Windows Operating Systems: 98 (second edition), ME, XP and 2000. If you would like to run this application on another operating system, please call Denver Instrument to check compatibility.

## **Installing the USB Application:**

Insert the CD provided with this instrument or download this application from our website at [www.denverinstrumentusa.com](http://www.denverinstrumentusa.com). On your computer, go to Start, Run and then browse to locate the CD and select "Setup.exe".

Follow the prompts. If at any time the program requires you to reboot, you must restart your computer and select the "Setup.exe" file again.

After installation is complete the program will appear in Start, Programs, USB Pinnacle, unless you changed the location during installation. Open this file.

The first time you connect your balance to your computer, the computer may prompt you for a driver. This driver will be found on your operating system install disk. Follow the prompts provided by your computer's operating system.



**Note:**

Install the USB application on your computer before connecting the USB cable to the balance.

## **Running the USB Application:**













Please refer to the USB Instruction Sheet provided on the CD or on our website at [www.denverinstrumentusa.com](http://www.denverinstrumentusa.com)

# Ethernet

---

Your Pinnacle Series balance is equipped with an Ethernet port. Ethernet can be used to exchange and transmit data from the balance to a computer via a local area network (LAN). Current capabilities allow the balance to be attached to a network, assigned an IP address and be seen by any computer on that network. The balance can also be tared via the Ethernet port. Please contact Denver Instrument Company to discuss any further access of the balance via the Ethernet.

## Define the IP Address:

1. Obtain an IP address from your network controller (IT manager). This IP address must be unique. Also obtain the subnet information.
2. Press **MENU**.
3. Press the  until "System" is highlighted, press the .
4. Press the  until "Ethernet" is highlighted, press the .
5. Press **ENTER** when IP Address is highlighted.
6. Enter the IP address
  - a. Press the  or the  until the desired digit is selected.
  - b. Press  to move to the next digit.
  - c. Repeat these steps until the IP address is displayed.
  - d. Press **ENTER** to accept.
7. Press the  until "Subnet" and press **ENTER**.
8. Enter the subnet
  - a. Press the  or the  until the desired digit is selected.
  - b. Press  to move to the next digit.
  - c. Repeat these steps until the subnet is displayed.
  - d. Press **ENTER** to accept.
9. Press the **TARE** key to return to the measurement screen or the  to return to the main menu.

## To View the balance on your LAN:

1. Open your browser.
2. Type the IP address assigned to the balance (example: `http:// 192.168.84.256`)
3. A simulated display of the balance will be displayed showing current time, date, stability and measurement of the balance.

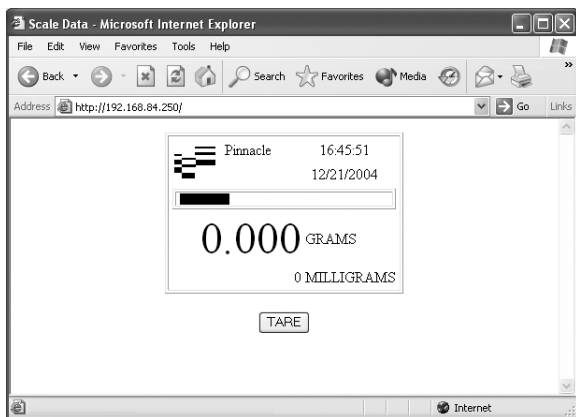

## To Tare your balance on your LAN:

1. Follow steps to view balance.
2. Click the "TARE" button on the browser screen. The balance will be tared remotely.

## To obtain or view XML formatted data for each measurement:

1. In your browser, type the IP address assigned to the balance and add `/xml` (example: `http://192.168.84.256/xml`).
2. The XML data of the current measurement is displayed.
3. The XML data can then be used in a variety of applications.

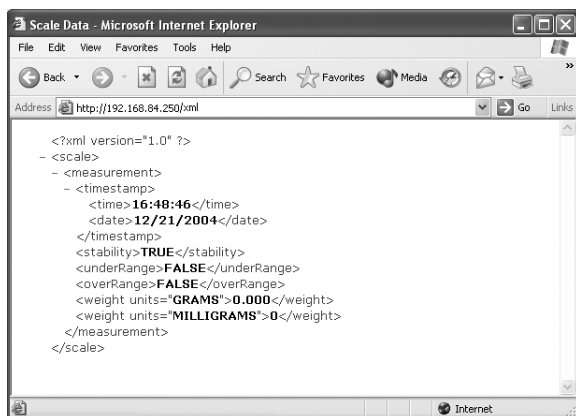

# Environmental Settings

---

Your balance can be set up for optimized weighing to compensate for varying conditions including vibration and drafts.

## Adjusting Filter Settings

The filter setting is set to take a number of readings and display the average on the screen. If you are in a very stable environment (i.e. on a marble slab and away from the heating/cooling system) there is no need to perform a high amount of filtering this also allows for a quicker response time. On the contrary, if the balance is in an unstable environment (i.e. on a production floor) quite a bit of filtering may be needed to give good results.



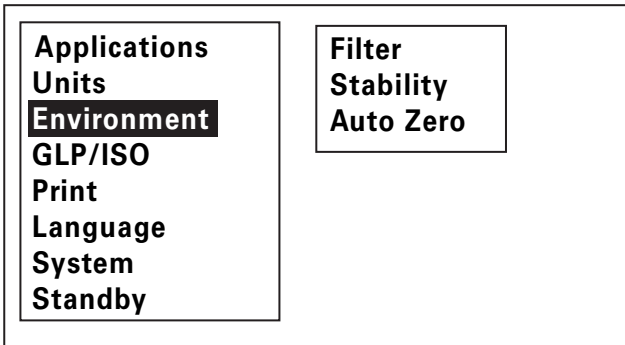



1. Press **MENU**.
2. Press the **▼** until "Environment" is highlighted, press the **▶**.
3. Press the **▼** until "Filter" is highlighted, press the **▶**.
4. Press **▲** or **▼** arrow until the desired filter setting is highlighted (low, normal or high) and press **ENTER**.
5. Press the **TARE** key to return to the measurement screen, or **◀** to return to the main menu..



System Screen







### Setting the stability icon:

Many laboratories rely on the stability icon to be displayed before a measurement is recorded. This balance can be adjusted to determine how much the weight can change before the stability icon disappears. A very coarse setting means there must be significant change for the stability icon to change to unstable, while a fine setting removes the stability icon with very little change.

1. Press the **MENU**.
2. Press the  until "Environment" is highlighted, press the .
3. Press the  until "Stability" is highlighted, press the .
4. Press the  or  arrow until the desired amount of change for the stability icon to disappear is highlighted (Fine, Normal, Coarse or Very Coarse) and press **ENTER**.
5. Press the **TARE** key to return to the measurement screen, or  to return to the main menu..

### Auto Zero:

When auto zero is on, any slight changes in the tared weight will be kept at 0.0.

1. Press **MENU**.
2. Press the  until "Environmental" is highlighted, press the .
3. Press the  until "Auto zero" is highlighted, press the .
4. Press the  or  arrow until the desired auto zero setting is selected (On or Off) and press **ENTER**.
5. Press **TARE** to return to the measurement screen, or  to return to the main menu.

# System

---

## Security

This balance can be set to prevent access to the menu and to not allow calibration.

### To set password:

1. Press **MENU**.
  2. Press **▼** until "System" is highlighted, press the **▶**.
  3. Press the **▼** until "Security" is highlighted, press the **▶**.
  4. Enter password.
    - a. Press **▲** or **▼** until the desired digit is selected.
    - b. Press **▶** to move to the next digit.
    - c. Repeat these steps until the desired password is displayed.
    - d. Press **ENTER** and accept to return to the measurement screen.
- When the menu key or calibration key is pressed, the password screen will be displayed.
  - Enter the password to turn off security.
  - To set security again, follow the "To set password" steps above.



**Note:**

While in password screen, pressing **TARE** will go back to measurement screen without allowing access to secure feature.

## RS232

This balance has a bi-directional RS232 port which enables communication with other serial devices such as a printer or computer. In order to communicate with another device the baud rate, parity, data bits and stop bits must be the same on both instruments.









<b>Security</b> <b>RS232</b> <b>Speaker</b> <b>Defaults</b> <b>Information</b> <b>Display</b> <b>IP Address</b> <b>DenverCal</b>	<b>Baud</b> <b>Bits/Parity</b> <b>Handshake</b> <b>Echo</b>
---	--

Your Pinnacle series balance requires the use of a custom, non-standard communication cable available from Denver Instrument, part number 902225.1. If you wish to manufacture your own cable, please refer to the pin-out below. Pin 9 must not be connected.









### Serial Cable Pin-outs:

Pinnacle Series DB-9 (male)	Standard RS-232 Connector DB-9 (female)
TxD 2	TxD 2
RxD 3	RxD 3
Ground 5	Ground 5
RTS 7	RTS 7
CTS 8	CTS 8

### To set baud rate:

1. Press **MENU**.
2. Press  until "System" is highlighted, press the .
3. Press the  until "RS232" is highlighted, press the .
4. When "Baud" is displayed, press .
5. Press the  or  until the desired baud rate is highlighted and press **ENTER**.
6. Press **TARE** to return to the measurement screen or  to return to the main menu.

### To set bits/parity:

1. Press **MENU**.
2. Press  until "System" is highlighted, press the .
3. Press the  until "RS232" is highlighted, press the .
4. Press the  until "Bits/Parity" is displayed, press .
5. Press the  or  until the desired serial setting is highlighted and press **ENTER**.
6. Press **TARE** to return to the measurement screen or  to return to the main menu.



**Note:**









Format is data bits, parity, stop bits, where:

N = none

E = even

O = odd

### To set handshake:

1. Press **MENU**.
2. Press  until "System" is highlighted, press the .
3. Press  until "RS232" is highlighted, press the .
4. Press  until "Handshake" is displayed, press the .
5. Press  or  until the desired setting (none, hardware, software) is highlighted and press **ENTER**.
6. Press **TARE** to return to the measurement screen or  to return to the main menu.

### To set print Echo:

1. Press **MENU**.
2. Press  $\blacktriangledown$  until "System" is highlighted, press the  $\blacktriangleright$  .
3. Press the  $\blacktriangledown$  until "RS232" is highlighted, press the  $\blacktriangleright$  .
4. Press the  $\blacktriangledown$  until "Echo" is displayed, press  $\blacktriangleright$  .
5. Press  $\blacktriangleup$  or  $\blacktriangledown$  to select "On" or "Off" and press **ENTER**.
6. Press **TARE** to return to the measurement screen or  $\blacktriangleleft$  to return to the main menu.

### Speaker

#### Set beep:

You can select if the balance will beep with each key press.

1. Press **MENU**.
2. Press  $\blacktriangledown$  until "System" is highlighted, press the  $\blacktriangleright$  .
3. Press the  $\blacktriangledown$  until "Speaker" is highlighted, press the  $\blacktriangleright$  .
4. Press the  $\blacktriangleup$  or  $\blacktriangledown$  until the desired beep setting is highlighted and press **ENTER**.
5. Press **TARE** to return to the measurement screen or  $\blacktriangleleft$  to return to the main menu.

### Information

Shows model of balance, software version, platform number, serial number and last calibration information. This information can be printed.

#### To view information screen:

1. Press **MENU**.
2. Press  $\blacktriangleup$  until "System" is highlighted, press the  $\blacktriangleright$  .
3. Press the  $\blacktriangleup$  until "Information" is highlighted, press the  $\blacktriangleright$  .
4. To print, press the **PRINT** key.
5. Press **TARE** to return to the measurement screen.

#### Sample of Information Output

```
-----  
model   PI-214 _____ balance model  
software 306A _____ software version  
Platform 0000137207 _____ balance weigh system ID  
Serial PI214054006 _____ balance serial number  
Last Cal INTERNAL _____ type of last calibration  
09/17/04 _____ date of last calibration  
16:04 _____ time of last calibration  
-----
```

## DenverCal

See Calibration section for information on DenverCal setting.

## IP Address

See Ethernet section for information on IP Address setting.

## Display

### To set the contrast:

1. Press **MENU**.
2. Press  $\blacktriangleleft$  until "System" is highlighted, press the  $\blacktriangleright$  key.
3. Press  $\blacktriangleup$  or  $\blacktriangledown$  until "Display" is highlighted, then press the  $\blacktriangleright$  key.
4. Press  $\blacktriangleup$  until "Contrast" is highlighted, press the  $\blacktriangleright$  key.
5. When "Adjust" is highlighted, press  $\blacktriangleup$  or  $\blacktriangledown$  until the desired contrast setting is displayed and press **ENTER**.
6. Press **TARE** to return to the measurement screen, or  $\blacktriangleleft$  to return to the main menu.

### To set the backlight level:

1. Press **MENU**.
2. Press  $\blacktriangleup$  until "System" is highlighted, then press the  $\blacktriangleright$  key.
3. Press  $\blacktriangleup$  or  $\blacktriangledown$  until "Display" is highlighted, then press the  $\blacktriangleright$  key.
4. Press  $\blacktriangleup$  until "Backlight" is highlighted, then press the  $\blacktriangleright$  key.
5. When "Adjust" is highlighted, press  $\blacktriangleup$  or  $\blacktriangledown$  until the desired backlight level is displayed and press **ENTER**.
6. Press **TARE** to return to the measurement screen, or  $\blacktriangleleft$  to return to the main menu.

# Standby

---

The Pinnacle Series has a standby mode to conserve energy. If no measurements are made during the length of the standby time, as defined by the user, the backlight will turn off and the display will show a clock.

Pressing any key returns the balance to weighing mode. If "Off" is selected in the standby setup menu, the balance will never go into standby mode.

### To set standby time:

1. Press **MENU**.
2. Press  $\blacktriangledown$  until "Standby" is highlighted, press the  $\blacktriangleright$  key.
3. Press  $\blacktriangleup$  or  $\blacktriangledown$  until the desired time (in minutes) is displayed.
4. Press **ENTER** to save standby time and return to the measurement screen.

# Restore Factory Defaults

---

To restore all settings to the factory defaults:

1. Press **MENU**.
2. Press **▼** until "System" is highlighted, press the **▶**.
3. Press the **▼** until "Defaults" is highlighted, press the **▶**.
4. When "Factory" is highlighted, press **ENTER**.



## **WARNING!**

**Setting factory defaults will reset all settings.**

### **List of Factory Defaults**

Count Mode	Off
Check Weighing	Off
Animal Weighing	Off
Target Weighing	Off
GLP/ISO Print	All Off
Statistics	Off
Formulation	Off
Primary Units	Grams
Secondary Units	Milligrams or Kilograms
Print Condition	On request, after stability
Print Format	Type 1
Environmental Filter	Normal
Environmental Stability	Normal
Auto Zero	On
Security	All Off
RS232 Baud	9600
RS232 Serial	8, None, 1
RS232 Echo	Off
Speaker	On
DenverCal: Automatic	Off
DenverCal:Internal	Off
Standby	Off

# Menu Tree

---

<b>Menu</b>	<b>Applications</b>	Normal Mode	
		Count Mode	5 10 20 50 100 Custom
		Check Weigh	Low Limit High Limit Enable
		Animal Mode	Automatic  Manual
		Target Weigh	
		Statistics	Enable Print Calculate Clear
		Formulation	

---

<b>Units</b>	Primary	Grams
	Secondary	Kilograms Milligrams Ounces Troy Ounces Pounds Grains Pennyweights Carats Tael-HK Tael-Singapore Tael-Taiwanese Mommies Drams Baht Tola

---

<b>Environment</b>	Filter	Low Normal High
	Stability	Fine Normal Coarse Very Coarse
	Auto Zero	On Off

---

<b>GLP/ISO</b>	User Date	MMDDYY DDMMYY	
	Time	24 hours 12 hours	
	Sample ID Number Header	On/Off	
<b>Print</b>	Mode	Manually Stable Interval	5 30 60 Custom
	Format	Type 1 Type 2 Type 3 Type 4 Type 5 Type 6 Type 7 Type 8	
<b>Language</b>	English German French Spanish		
<b>System</b>	Security	Password	
	RS232	Baud Rate	300 600 1200 2400 4800 9600 19200 38400 57600 115200
		Bits/Parity	8, N, 1 8, E, 1 8, O, 1 7, E, 1 7, O, 1
		Handshake	None Hardware Software
	Speaker	On Off	
	Defaults Information	Factory	
	Display	Contrast Backlight	Adjust Adjust
	Ethernet	IP Address Subnet	
	Denver Cal	Automatic Internal Off	
	<b>Standby</b>		

# Cleaning and Maintenance

---

## Repairs

Repair work must be performed by qualified factory-trained personnel only.

### Note

This unit contains no user serviceable parts. All replacement parts should be obtained from the manufacturer. Please refer to the inside front cover of this manual for the phone number of your sales and service representative.



### Warning!

Never lift balance by the weighing pan as this may cause damage to internal mechanisms.  
Always lift and transport the balance by its base.

## Cleaning

Caution! Disconnect the balance AC adapter from power source prior to cleaning. Make sure that no liquids enter the balance housing. Do not use aggressive cleaning agents such as cleansers. A mild detergent is recommended. Disassemble the Pan Assembly and clean the floor pan, breeze ring, pan support and cover pan separately, then reassemble. Clean the balance with a piece of cloth. After cleaning, wipe the balance down with a dry, soft cloth. Recalibration of the balance is recommended after cleaning.



### Warning!

If there are any indications that safe operation of the balance is no longer warranted, turn off power and disconnect from AC power source immediately.

## Safety Inspection

Safe operation of the balance is no longer assured if there is visible damage to the AC adapter or cord, the AC adapter no longer functions properly or the AC adapter has been stored for a long period under unfavorable conditions.

# Troubleshooting

---

## **OVER**

### **CAPACITY ERROR**

The load exceeds the balance capacity.

Unload the balance or look for obstruction.

---

Display capacity is exceeded.

Decrease weight on balance.

---

Damage has occurred.

Call Denver Instrument.

---

## **UNDER**

### **CAPACITY ERROR**

The load is too low.

Check pan position.  
Unload pan and cycle power.

---

Damage has occurred.

Call Denver Instrument.

---

## **CAL**

### **ADD WEIGHT**

Calibration is entered without weight on pan.

Add weight and press **CAL** key again.

---

## **CAL**

### **OUT OF RANGE**

Weight cannot be recognized.

Clear pan and add appropriate weight.

---

### **Other errors**

Error has occurred.

Cycle Power. Call technician for further assistance.

---

# Accessories

---

Draft shield (for mg units only)	602643.1
Draft ring (for round pan toploaders only)	902191.1
Security Device: Under the counter mounted	36800110.1
Security Device: Chain and lock	400171.1
In Use Cover (analyticals and round pan models)	602619.1
In Use Cover (square pan models)	602620.1
Dot Matrix Printer	902224.1
Computer Software: BalanceTalk XL for direct download into Excel	902227.1
9-pin cable for balance	902225.1
Weigh Below Hanger	77000440.8
Calibration Weights - call your distributor for a complete list	

# Warranty Instructions

---

1. Please return the prepaid, pre-addressed Purchase Registration Card to Denver Instrument Company promptly upon your purchase of the Denver Instrument product. The return of the card is not a condition precedent to warranty coverage.
2. If you have any questions about a Denver Instrument product, please contact the nearest Denver Instrument office as listed below.
3. If it becomes necessary to return your Denver Instrument product for service, you must obtain a "Return Authorization Number". Please pack the product securely in its original approved packing carton or an other suitable container. Include your Return Authorization Number on the shipping label. Shipping charges must be fully prepaid.

Return to authorized distributor or :

*North and South America:*

**Denver Instrument Company  
6542 Fig Street  
Arvada, Colorado 80004  
1-800-321-1135  
Tel: 303-431-7255  
Fax: 303-423-4831**

*U.K. and Ireland:*

**Denver Instrument Company  
Denver House, Sovereign Way  
Trafalgar Business Park  
Downham Market  
Norfolk PE38 9SW England  
Tel: 44 136 63862 42  
Fax: 44 136 63862 04**

*Europe, Asia and Australia:*

**Denver Instrument GmbH  
Robert-Bosch-Breite 10  
37079 Gottingen Germany  
Tel: 49 551 20977 31  
Fax: 49 551 20977 39**



*North and South America:*

**Denver Instrument Company  
1401 17th St. Suite 750  
Denver, Colorado 80202  
1-800-321-1135  
Tel: 303-431-7255  
Fax: 303-423-4831**

*U.K. and Ireland:*

**Denver Instrument Company  
Denver House, Sovereign Way  
Trafalgar Business Park  
Downham Market  
Norfolk PE38 9SW England  
Tel: 44 136 63862 42  
Fax: 44 136 63862 04**

*Europe, Asia and Australia:*

**Denver Instrument GmbH  
Robert-Bosch-Breite 10  
37079 Gottingen Germany  
Tel: 49 551 20977 31  
Fax: 49 551 20977 39**

*[www.denverinstrument.com](http://www.denverinstrument.com)*