

Operation Manual

Model 215 pH Meter

Model 220 pH/Conductivity Meter

Model 225 pH/Ion Meter

Model 250 pH/Ion/Conductivity Meter

Model 260 Titration Controller

Model 270 pH/Ion/Conductivity/Titration Controller

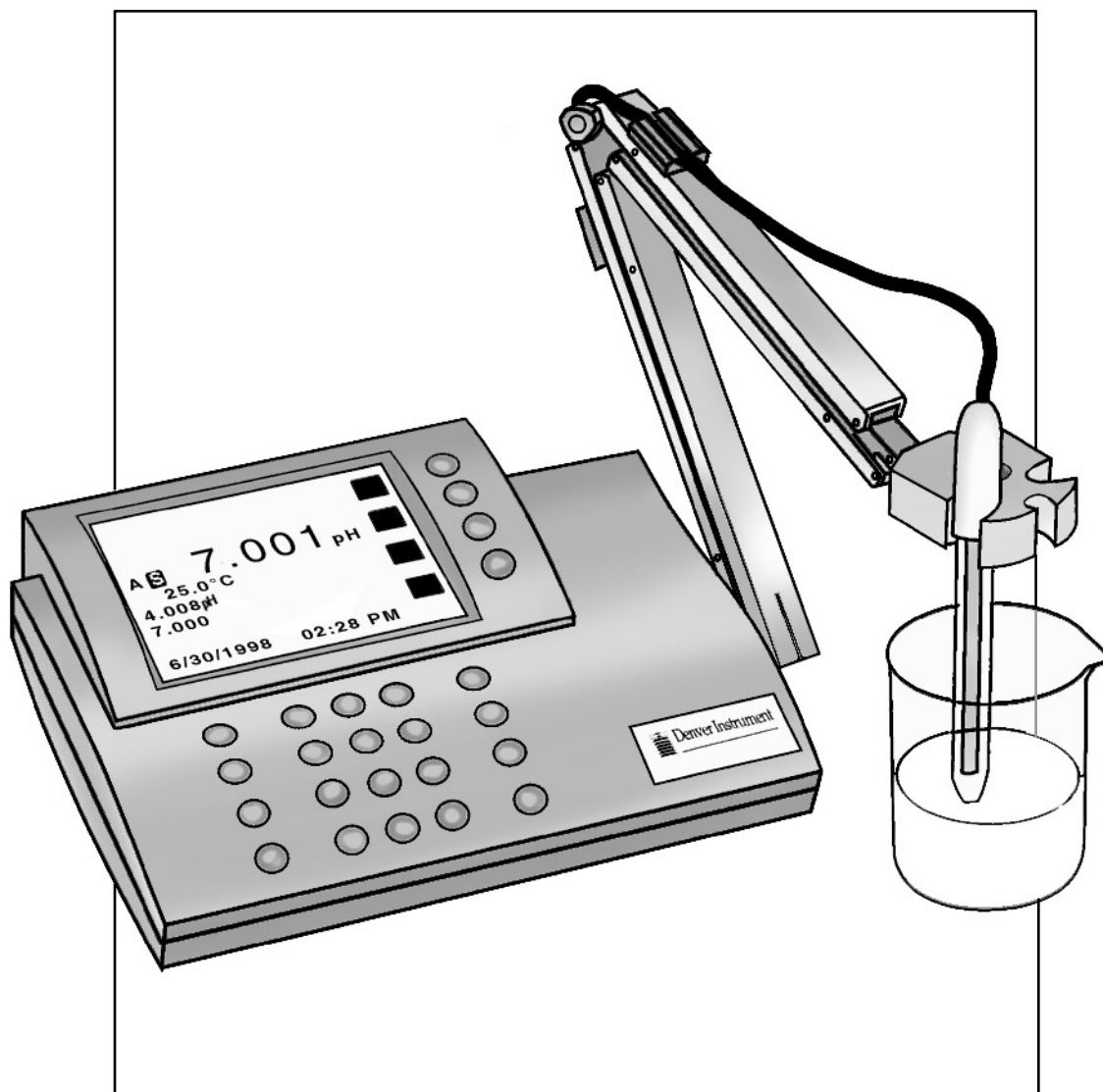

This manual covers Software Version 3

Manual and User Interface
© Copyright Denver Instrument Company, 1999
All rights reserved.

Table of Contents

Quick Start Guide for pH Measurement	Page ii
Introduction	
Menu Keys, Softkeys and Display	1
Electrode Connectors and Inputs	2
LCD Display	3
Function Keys	4
Electrodes	
Preparing pH and Ion Selective Electrodes.	6
Connecting Electrodes.	6
Using and Storing Electrodes	7
pH Electrodes	7
Solid-State FET Electrodes	7
Ion Selective Electrodes	7
Meter Setup	
Meter Setup Menu	8
pH Mode	
pH Mode Standardization Menu	9
Cal Reminder Menu	9
Select Custom Buffer Set	9
pH Mode Options Menu.	10
Standardizing and Measuring pH.	12
Clearing Buffers.	12
mV Mode	
mV Mode Standardization Menu.	13
mV Mode Options Menu	13
Clearing Relative mV Mode.	13
Quick Start Guide for Ion Measurement.	14
Ion Mode	
Ion Mode Standardization Menu	15
Standardizing and Measuring Ion	16
Measuring Ion using a Known Addition type (incremental ion) method	17
Quick Start Guide for Conductivity/Resistivity/Salinity/TDS Measurement	18
Conductivity/Resistivity/Salinity/TDS Modes	
Conductivity/Resistivity/Salinity/TDS Standardize Menu	19
Conductivity/Resistivity/Salinity/TDS Options Menu.	20
Quick Start Guide for Coulometric Karl Fischer Titration	21
Karl Fischer Titrator Setup	22
Karl Fischer Titration Mode	24
Running a Titration	24
Titrator Status and Operating Data	25
Titrator Setup Menu.	26
Cleaning the Titration Cell.	27
Troubleshooting Karl Fischer Titration	29
Modifying Titration Protocols	30
Data logging	31
Troubleshooting	32
Meter Specifications	33
pH Theory	34
Ion Selective Electrode Theory	34
Determining Isopotential Point	35
RS-232 Serial Interface Meter Command Set.	36
Maintenance	38
Menu Tree Diagrams	Inside Back Cover

Quick Start Guide for pH Measurement

1. Connect power cable to meter connector on the rear panel marked "power" and to AC power source.

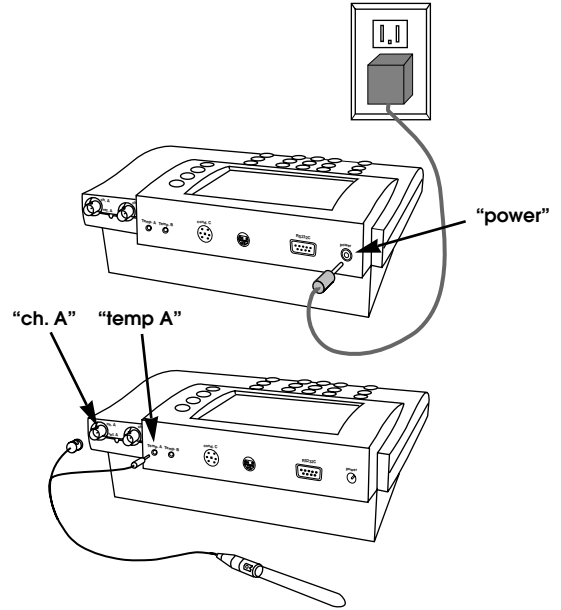

2. Connect the glass pH/ATC electrode to the channel A BNC connector marked "ch.A" and to the channel A temperature connector marked "temp A".

3. Verify the meter is in pH mode on channel A. Use the **Mode** key and **Channel** key to set the meter to the correct mode and channel if necessary. (See Function keys).

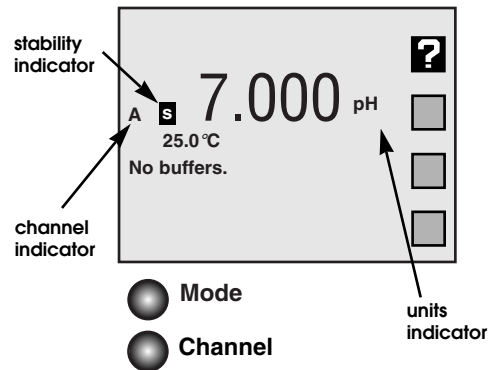

4. Standardize the electrode by immersing the electrode in a buffer, pressing **Standardize**, pressing **1) Auto-enter a buffer** and following the prompts. Repeat this step to enter each buffer. The meter will check the electrode and buffers, and give an error message if there is a problem.

Press **Standardize** to enter or clear buffers, select buffers, set resolution, or set other parameters for the current mode and channel.

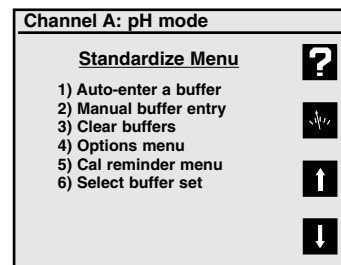

5. The display shows the current measurement, and indicates a stable reading with the **S** indicator. Press **Cal Data** to review and graph the electrode calibration data.

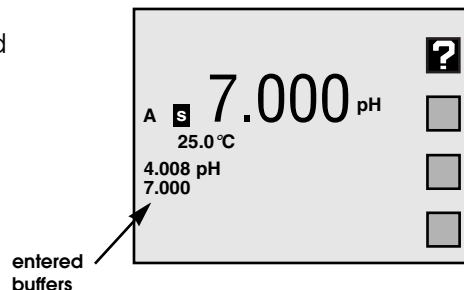

Introduction

This Denver Instrument electrochemistry meter is a powerful, versatile and accurate instrument. It features easy menu-based operation with easy to understand prompts and electrode/standard error checking.

These meters feature many advanced options, such as programmable stability criteria, programmable standardization reading delay times, multi-channel operation, fast reading update rates of twice per second for all channels, programmable alarms, programmable data logging of 500 data points and a superb RS-232 serial interface for controlling the meter and obtaining data.

Denver Instrument's Second Generation Series 200 meters use flash programmable ROM for the operating code. The meter operating code can easily be upgraded as new features are made available.

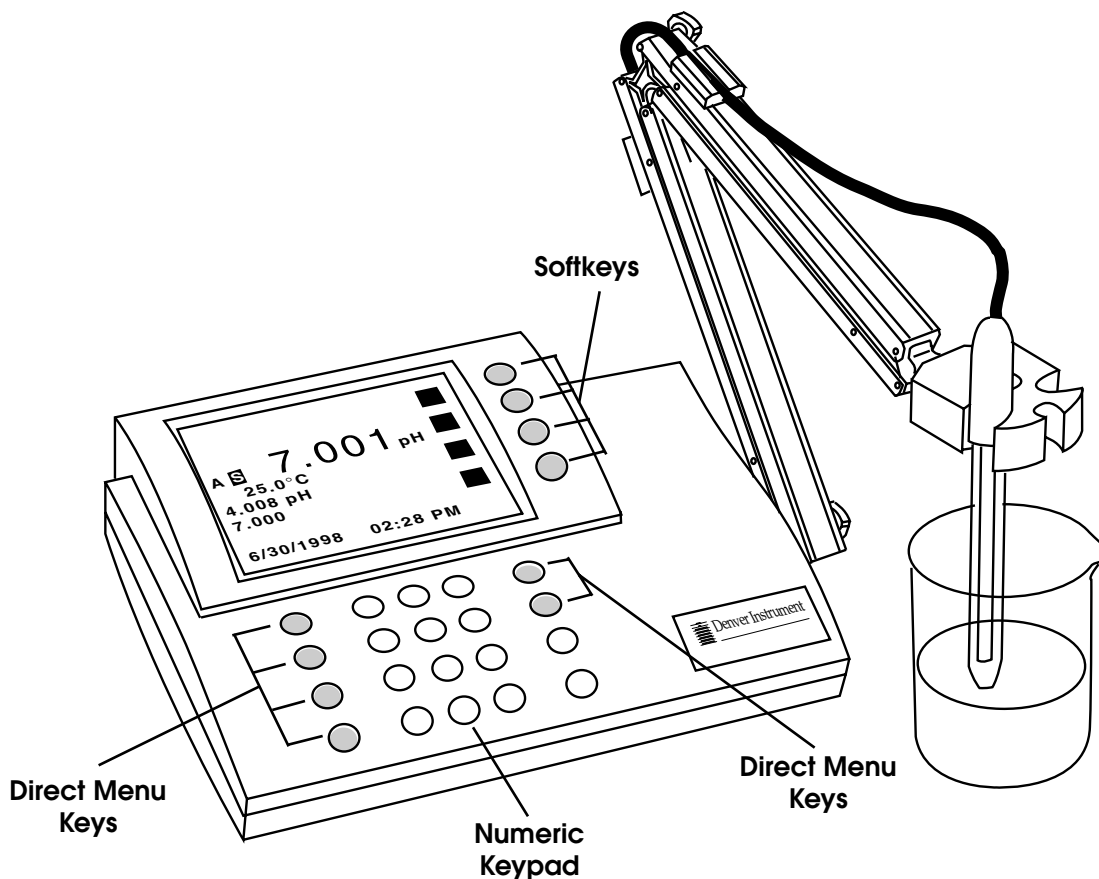

Direct Menu Keys, Softkeys and Display

The meter uses six **Direct Menu** keys to access the menus and operations (such as selecting pH mode, standardizing, checking electrode calibration data, selecting the electrode channel).

There are four **Softkeys** that provide additional operations; these Softkeys change their function as needed and each Softkey has an icon to indicate its current function.

The display is a backlit quarter-VGA screen capable of displaying all four electrode channels of a Model 250 and eight channels (four electrode channels and four Karl Fischer titrators) for a Model 270 simultaneously. The backlight will turn off after a period of non-use (the default is 45 minutes, set this time in the Setup menu); pressing any key will automatically turn the display backlight on again.

Introduction

Electrode Connectors and Inputs

BNC ("ch.A" or "ch.B") connectors: pH, Ion Selective Electrodes and ORP (redox) electrodes attach to the meter through a BNC ("round twist-on") connector to channel A or channel B (Models 225 and 250 only).

Temperature ("temp A" or "temp B") connectors: use to connect the 2.5mm mini-phone plug from the temperature sensor (built into the pH electrode with the Denver Instrument standard pH/ATC electrode) for Automatic Temperature Compensation (ATC).

Reference ("ref.A" or "ref.B") connectors: use for attaching a reference electrode tip-pin plug when a separate reference electrode is used.

Conductivity DIN ("ch.C conductivity") connector: use to connect a 4-band conductivity/ATC cell. These 4-band cells offer improved linearity and stability over older 2-band conductivity cells. (Models 220 and 250 only).

FET DIN ("ch.F FET") connector: use to connect the Denver Solid-State Field Effect Transistor (FET) pH/ATC electrode. These non-glass pH electrodes offer certain advantages over conventional glass pH electrodes.

Serial port ("RS232") DB-9 connector: use to connect a serial printer or Personal Computer. This bi-directional interface outputs data and receives meter commands.

Power ("power") connector: use to connect a 5.5mm OD x 2.1 ID coaxial connector with 12VDC at 500mA (center pin negative).

Titration Network ("titration network") connector: use to connect up to four Coulometric Karl Fischer titrators.

Note: Not all models have all connectors shown.

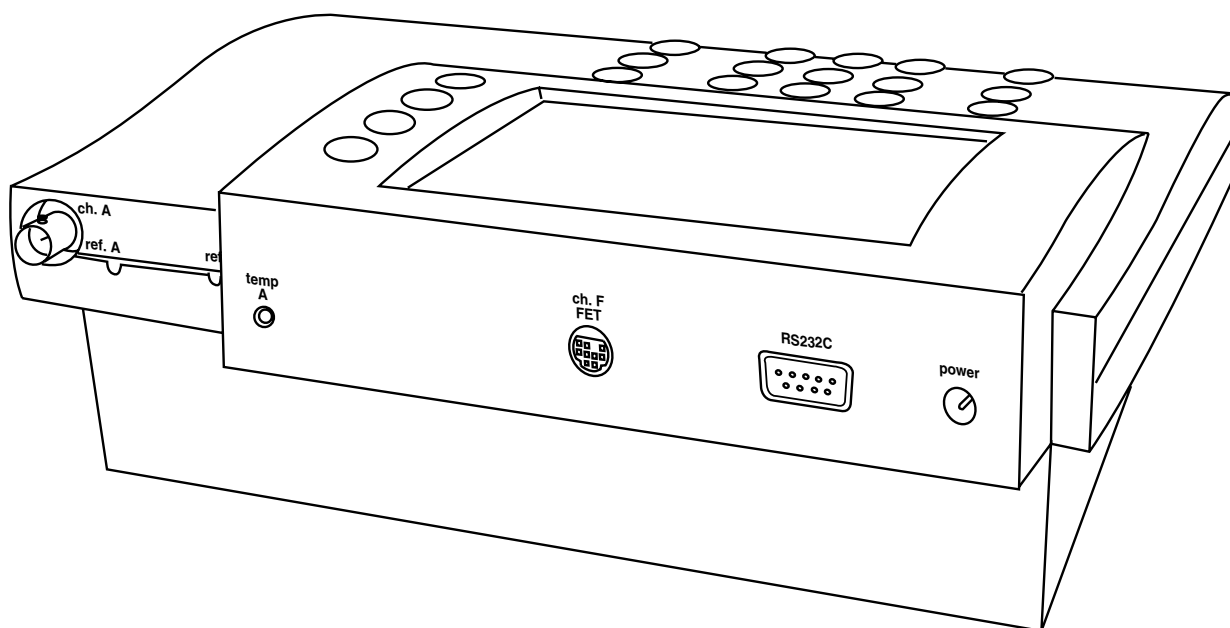

Connectors for Model 250

Display

Note: Not all of the following will display at the same time.

- A Result:** current measurement.
- B Units:** displays the units for the current measurement. Examples: pH, mV, mg/L F-, $\mu\text{S}/\text{cm}$ or $\Omega\text{-cm}$.
- C Softkey icons:** show the current function assigned to each softkey.
- D Calibration due reminder:** the **CALI** icon means a calibration is now due.
- E Date and time:** displayable in different formats.
- F Datalogging:** the **LOG** icon indicates datalogging is active.
- G Buffers/Standards:** in single channel mode, all entered buffers or standards are displayed. A "!" symbol beside a buffer indicates that buffer is out of the entered calibration valid time (See Calibration reminder, page 9).
- H Temperature:** displays the measured temperature when an electrode with ATC or separate temperature probe is attached. Shows "M" when a manually entered temperature is being used.
- I Alarm:** "*" indicator means data is outside the set alarm limits.
- J Channel:** indicates which electrode channel (input) or titrator channel is being displayed. Channels A & B are BNC electrode inputs, Channel C is a conductivity cell input, and Channel F is a FET pH electrode input. Channels T1 through T4 are Karl Fischer (KF) titrators (Models 260 & 270).
- K Stability:** the **S** indicates the electrode is stable to the selected criteria.
- L Multiple Channel:** display can show two (Model 215), three (Models 220 and 225) or four (Model 250) electrode measurements with temperature simultaneously. Models 260 and 270 can display four KF titrators simultaneously.
- M Out-of-range or non-valid reading:** dashes indicate a measurement is not available. This usually means the reading is out of range, or can mean in ion mode that no standards have been entered, or strict calibration has been set and the calibration expired.

Single channel display

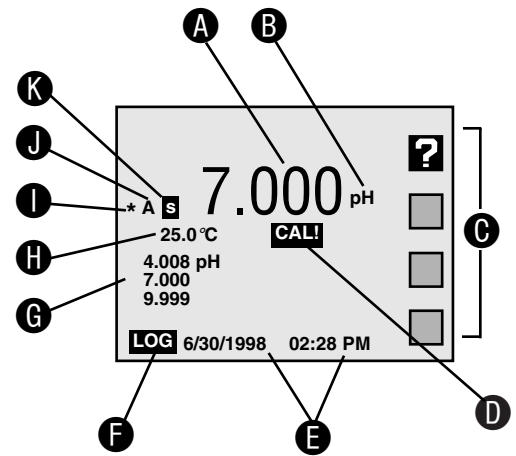

Dual channel display

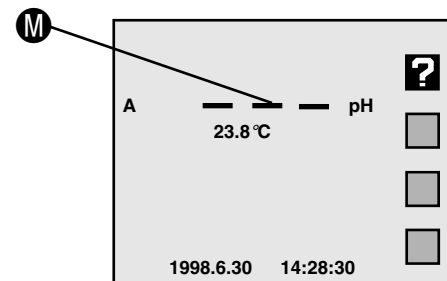
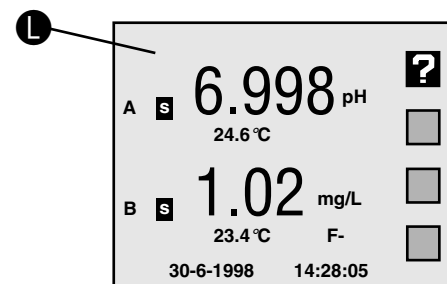

Function Keys











- A Mode:** Selects the mode: pH, mV (Model 215), Ion (Models 225 and 250), Conductivity - Resistivity-NaCl Salinity-Practical Salinity-TDS (Models 220 and 250) to use for the currently selected channel (electrode input). Select KF protocol for selected titrator (Models 260 and 270).
- B Standardize:** Enters buffers or standards for the currently selected channel and mode. Use to enter pH buffers, relative mV offset, ion standards or conductivity /resistivity standards. Use to modify a KF titration protocol.

Also used to change other settings which affect the measurement.
- C Cal Data:** Displays and graphs buffers or standards with time and date stamp and electrode calibration data for the selected channel and mode. Shows KF titrator operating data such as drift rate, reagent condition, and statistics on the last titrations.
- D Channel:** Selects the channel(s) (electrode inputs) to display. The Model 215 can display one or two channels simultaneously (Channels A and F). The Model 225 can display one, two or three channels simultaneously (Channels A, B and F). The Model 220 can display up to three channels (Channels A, C and F). The Model 250 can display up to four channels (Channels A, B, C and F). Models 260 and 270 can display up to four KF Titrator channels.
- E Setup:** The Setup menu is used to set various general meter settings, such as date and time, display contrast, keypress beep and serial port. Use Titration setup menu to access titration protocols and control titrators.
- F Data Log:** Displays the datalogging menu used to set datalogging and view the stored Data Log (see Datalogging).
- G Clear:** Exits from the current menu and returns to the previous menu, cancels the current operation or clears a number entry.
- H Enter/Print:** Accepts numeric values, menu selections or pending operations. In the main measure screen, acts as a Print key,

sending all current measurements to a printer/ computer through the serial port and stores the measurements in the Data Log.

- I Softkeys:** These four keys access different operations at different times. Most menus offer a "Help" softkey and the "Measure" softkey, which allows a direct return to the main measuring screen, exiting all menus immediately. The "Up Arrow" and "Down Arrow" softkeys offer one way to select a menu item. The "Left Arrow" key is a backspace, active during number entry.
- J Numeric Keys:** Pressing a number key selects a numbered item in a menu. The number keys also allow entering values for buffers, standards, and various meter settings.

Softkeys

-  Help
-  Measure
-  Scroll up
-  Scroll down
-  Backspace
-  Graph
-  Exponent number entry
-  Incremental ion method
-  Measure lock
-  Measure unlock
-  Titrator Start/Stop

Function Keys

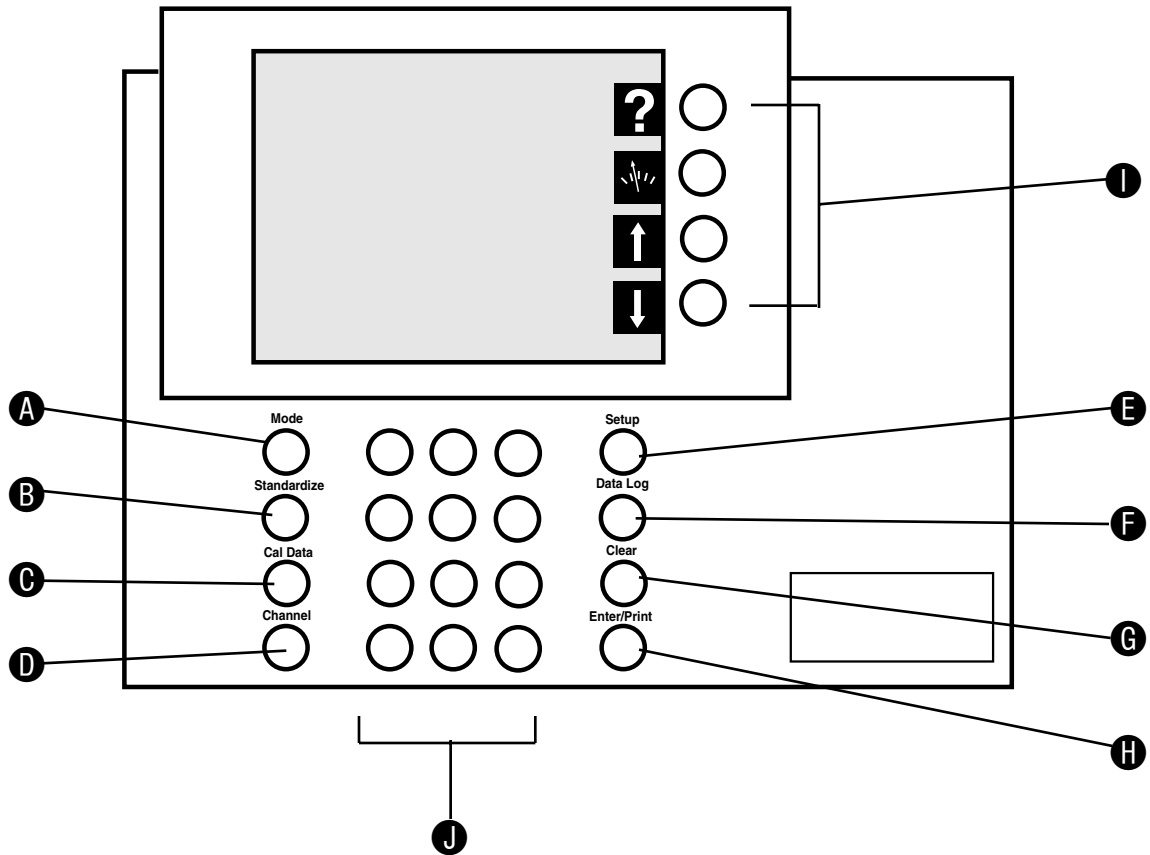

Channels

The Channel key is used to turn on or off each available channel. In single-channel operation, additional information for the selected channel is provided, including a display list of all entered buffers or standards. In multi-channel operation, the Mode, Standardize and Cal Data menus ask for the channel before accessing the menu.

The Model 215 offers single or dual channel operation using channel A (pH and ORP electrodes) and channel F (Solid-state FET pH electrode). The Model 225 offers up to three-channel simultaneous operation of channel A and channel B (pH, ORP and Ion Selective Electrodes) and channel F (Solid-state FET pH electrode).

The Model 220 has Channel A (pH and ORP electrodes), Channel C (Conductivity cells) and Channel F (solid-state FET pH electrode). The Model 250 provides up to four channel measurement with Channel A and Channel B (pH and ORP and Ion Selective electrodes), Channel C (Conductivity cells) and Channel F (solid-state FET pH electrode). The Model 270 adds four Coulometric Karl Fischer (KF) titrator channels, and the Model 260 has only the four KF titrator channels.

Model 250 Select Channel screen

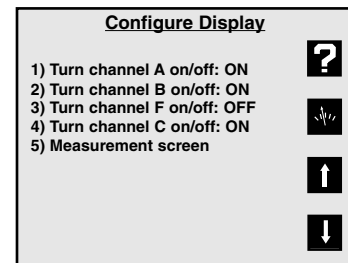

 Channel

Electrodes

The meter allows you to use a variety of glass membrane ("glass") pH/ATC electrodes, ion selective electrodes, Conductivity/ATC cells, the Denver Instrument Field Effect Transistor (FET) Solid-State pH/ATC electrode, temperature (ATC) probes, combination electrodes using a BNC connector, or separate electrode pairs with BNC connector and reference pin.

To measure	Use channel (connector)	
pH	A (BNC)*	or B (BNC)*
mV (ORP)	A (BNC)*	or B (BNC)*
ion (ISE)	A (BNC)*	or B (BNC)*
Conductivity	C (DIN)	
Resistivity	C (DIN)	
Salinity	C (DIN)	
TDS	C (DIN)	
pH (FET)	F (mini-DIN)	

*Separate reference electrodes can be used with "Ref A" or "Ref B" connectors

Preparing Electrodes and Conductivity Cells

Remove the wetting cap or storage cap from the electrode. Before first using your pH electrode or whenever the electrode is dry, soak it several hours in an electrode filling or storage solution (3 Molar KCl solution) or in a buffer for pH electrodes. Condition ISE's in the recommended solutions. Rinse Conductivity cells with deionized water before use.

Connecting Electrodes

pH, ORP or ISE electrodes (with BNC connector):

Connect the electrode to the BNC input, either channel A or channel B (Models 225 and 250 only), located at the rear of the meter. Push in and rotate the electrode's BNC connector until it locks in place. Connect the ATC connector to the temp. A or temp. B connector. To disconnect, twist the BNC connector in the opposite direction and pull.

Electrode Pair Using a Reference Electrode (with Reference Pin Plug):

Connect the indicating electrode to the BNC input. Connect the reference electrode to the Reference input. Push the electrode's tip pin plug into the input to connect and pull out to disconnect.

Conductivity Cells (with DIN connector):

Align and push in the DIN connector fully to the channel C input (Models 220 and 250 only). Pull carefully to disconnect.

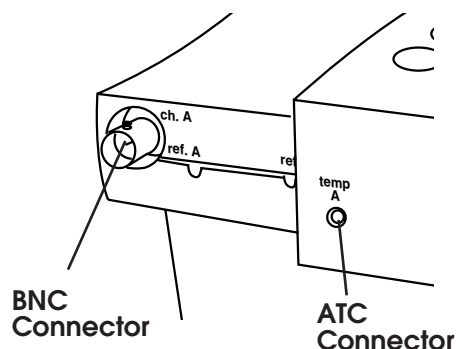
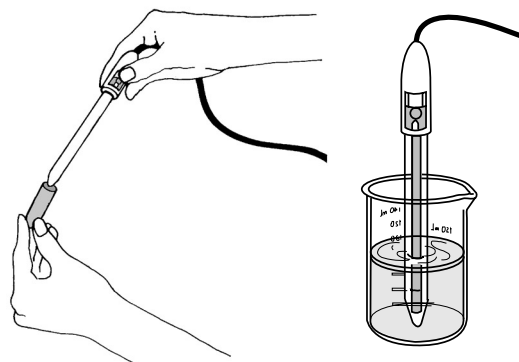
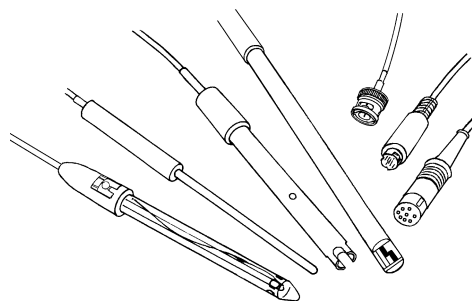

Channel C
Conductivity Input

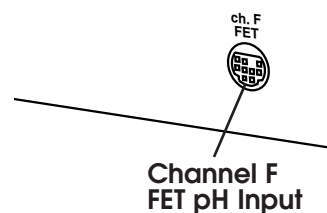

Electrodes

Using and Storing Electrodes

pH Electrodes

- Provide moderate stirring for faster electrode response.
- Leave the fill hole open during all use.
- Rinse the electrode between each measurement with a portion of the next sample or buffer to be measured, or with deionized or distilled water.
- Keep glass electrodes wet when not being used by placing some electrode filling solution in the wetting cap and storing with the wetting cap on.
- Keeping glass electrodes “wet” will improve their performance. Store electrodes in electrode filling solution or storage solution (3M KCl).

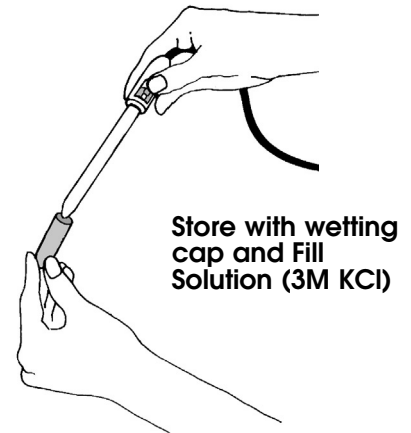
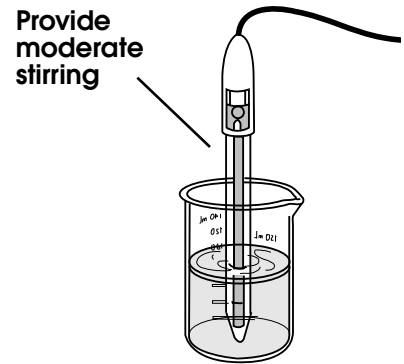

Solid-State FET Electrode

- All models allow use of both standard glass pH/ATC and Solid-State FET (Field Effect Transistor) pH/ATC electrodes. The meter can store a calibration for both types of electrodes. Plug the FET electrode into the channel F mini-DIN input.
- Allow the FET about 1 minute to stabilize when first connected. The FET electrode can be stored dry or in electrode storage solution. Provide moderate stirring.

Ion Selective Electrodes

- Add proper amount of Ionic Strength Adjuster (ISA) to all standards and samples, usually 1 mL ISA to 50 mL standard or sample.
- Provide moderate stirring for faster electrode response.
- Rinse the electrode(s) between each measurement with a portion of the next sample or standard to be measured, or with deionized or distilled water.
- Follow the instruction sheets for the individual electrode. Store as recommended.

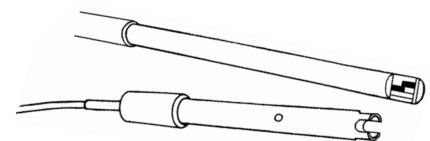

Conductivity Cells

- When changing samples or standards, immerse the cell into the new solution, then lift and allow solution to drain out. Repeat two more times.
- Gently tap cell to dislodge air bubbles.

Meter Setup

Meter Setup Menu

Press **Setup** to access the Meter Setup menu:

1. **Time and date menu:** use to set the time format (HH:MM AM/PM or HH:MM:SS), set the time, set the date format (MM/DD/YY, DD-MM-YY or YYYY.MM.DD), and set the date.
 2. **Select temperature units:** use to select temperature measurement and display in degrees Celsius, degrees Fahrenheit or Kelvin.
 3. **Select contrast:** use to select the display contrast, making the displayed characters lighter or darker. Select setting "5" for typical conditions.
 4. **Select baud rate:** use to set the serial RS232 port baud rate. This must match the baud rate setting of the printer or computer being used with the meter. **Titration setup menu** (Models 260 & 270): use to modify, select and print titration protocols, set titration intermediate results printout, select balance type for the titrators, and control titration stirrers.
 5. **Setup serial port:** use to configure the serial port start bits and parity setting. This must match the settings of the printer or computer being used with the meter. **Serial port menu** (Models 260 & 270): use to set serial port baud rate, start bits and parity.
 6. **Keypress beep on/off:** use to turn on or off a "beep" upon each keypress as an audible signal that a key has been pressed.
 7. **Select video color scheme:** use to set the display to black characters on a white background or white characters on a black background.
 8. **Show meter information:** use to show the meter model, software version and serial number.
 9. **Enable measure lock:** use to enable the measure lock where a stable measurement is locked (frozen) for later review. Stability criteria should be set to SLOW for all channels and modes in use.
 0. **Enable strict calibration:** use to set strict calibration where no measurements are displayed if the calibration reminder has expired.
- "±" **Set screen saver timeout:** use to set a time for the backlight to turn off and the screensaver to activate.
- "•" **Restore factory defaults:** use to reset all settings to factory defaults. On occasion it may be useful to completely reset the meter, for example, if other users have changed a setting.



Warning!

A reset also clears all electrode standardizations.

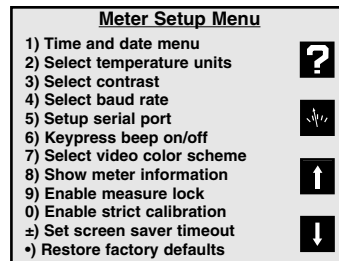

Setup

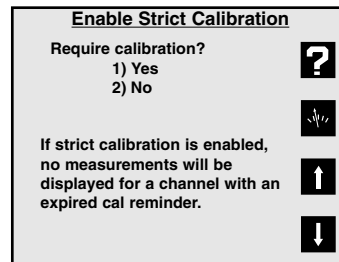
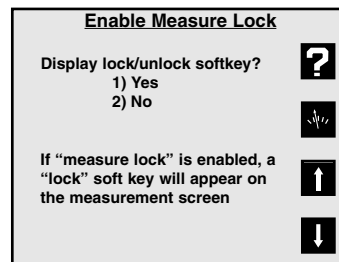
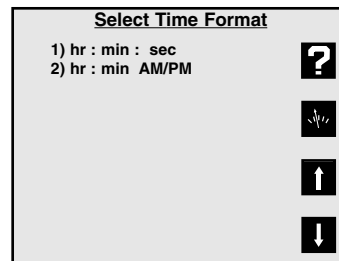

pH Mode

pH Mode Standardize Menu

Press **Mode** and select **1) pH**.

Press **Standardize** and the pH Mode Standardize Menu appears:

1. **Auto-enter a buffer:** use to add a new buffer which is auto recognized by the meter, or update an existing buffer. Follow the prompts.
2. **Manual buffer entry:** use to enter a buffer value by manually entering the pH of the buffer.
3. **Clear buffers:** use to clear all buffers entered for the current channel (pH mode). If all entered buffers are being re-entered, it is usually not necessary to clear buffers before re-entering them.
4. **Options Menu:** A menu of additional specific pH mode settings. (See page 10).
5. **Cal reminder menu:** use to set a timer reminding you to recalibrate. A **CAL!** icon will appear on the main screen and an exclamation mark will appear beside the buffers for which time has expired.

The calibration reminder is a reminder of when electrode calibration (with buffers) should be redone. It is based on elapsed time from the oldest entered buffer.

If strict calibration is set (see Meter Setup Menu), when a calibration has expired the **CAL!** icon appears, and "- - -" is displayed in place of the measurement. No measurements can be obtained until a calibration is performed.

Note: When strict calibration is set, the calibration reminders for all channels are turned ON, and can't be turned off from the Cal Reminder Menu.

6. **Select buffer set:** There are five auto-recognition buffer sets and the option to configure and use a custom buffer set of your own.

Select custom buffer set

Use Custom Buffer Set to make a set of buffers containing the specific buffers in use (up to five buffers). Select Custom Buffer Set, configure the custom buffer set, then buffers from this set will be automatically recognized and entered.

Custom buffers can have any numeric pH value, or can be selected from the built-in temperature corrected buffers. Using the built-in buffers allow temperature correction of the pH values of the buffers, offering more accuracy.

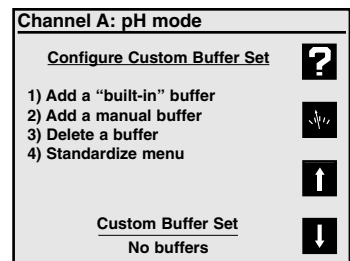
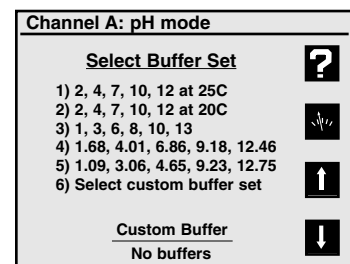
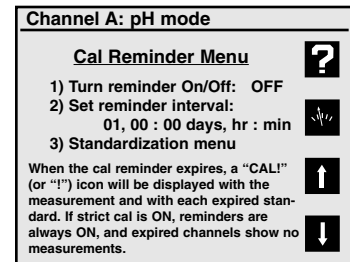
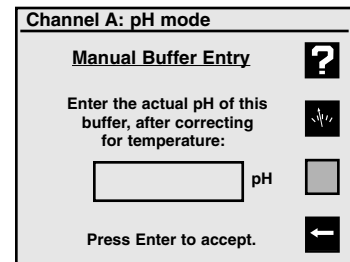
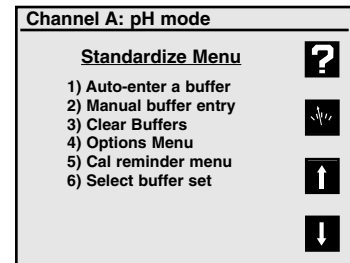

pH Mode

pH Mode Options Menu

1. **Select resolution:** use to set pH readings to 0.1, 0.01, or 0.001 pH units.
2. **Select stability criteria:** use to set stability criteria to slow, medium or fast to match the electrode's speed of response and the variability of the signal allowed for a "stable" (**S**) measurement.
3. **Select signal averaging:** use to set filtering of the electrode signal to very slow (10 readings), slow (8), medium (6), fast (4) or very fast (2). Slower settings give more stable readings, although may require longer times to reach stability.
4. **Set standardization delay:** use to set a reading delay time for the meter to wait before accepting an electrode signal during standardization. Programming a standardization reading delay helps slow responding electrodes reach equilibrium before the electrode signal is accepted.
5. **Set pH slope:** use to set a known electrode slope used by the meter with a zero- or single-point standardization. The normal default slope is 59.16 mV/pH. The meter allows between 80 and 120 % efficiency to be entered.
6. **Standardize menu:** Returns to the pH mode Standardization Menu.
7. **Manual temperature menu:** use to set a temperature to be used in the absence of an ATC probe or when manually overriding the ATC.
8. **Data alarm menu:** use to set pH limits. If the limits are exceeded an alarm indication ("*") is displayed and recorded with any data points placed in the Data Log.
9. **Set isopotential point:** use to set an isopotential point for use in high accuracy electrode measurements (See Isopotential, page 20).

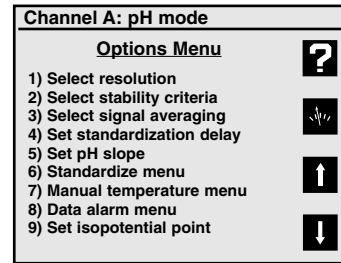

pH Mode

Notes:

1. Auto-recognized buffers are found in the Auto-recognized built-in buffer sets. These buffers are auto-recognized by the meter, and are also automatically temperature corrected for the variation of buffer pH with temperature.
2. When manually entering buffers, the exact pH of the buffer at the current temperature must be entered. All buffers change pH with temperature. For best accuracy, either use the built-in buffers or make sure manually entered buffers are at the expected temperature (so that their pH as entered is correct).
3. Auto-recognition Buffer Sets:
 - 1) 2, 4, 7, 10, 12 (nominal value adjusted at 25°C)
 - 2) 2, 4, 7, 10, 12 (nominal value adjusted at 20°C)
 - 3) 1, 3, 6, 8, 10, 13
 - 4) 1.68, 4.01, 6.86, 9.18, 12.46 (NIST buffers)
 - 5) 1.09, 3.06, 4.65, 9.23, 12.75 (DIN buffers)
 - 6) Select custom buffer set

4. Temperature Correction of Electrodes and Buffers

The meter automatically compensates for the temperature dependence of the electrode's response when measuring pH. The meter also compensates for buffer change in pH value with temperature. Temperature compensation is based on temperature either from an ATC probe or a manually entered temperature.

Actual Buffer pH vs. Temperature
pH 4.00(4.01)/7.00/10.00 buffer (nominal 25°C)

Temperature (°C)	Buffer 4	Buffer 7	Buffer 10
30	4.016	6.991	9.947
25	4.008	7.003	10.000
20	4.003	7.020	10.057
15	4.000	7.042	10.119
10	3.998	7.069	10.187

Using a Solid-state FET (Field Effect Transistor) pH/ATC Electrode

By turning channel F (FET) on, a Denver Instrument FET pH/ATC electrode can be directly used. pH and mV modes are available with the FET electrode. FET devices can have large offset potentials that vary with each transistor chip, so Manual buffer entry must be used to enter the first buffer. After one buffer has been entered using "Manual buffer entry", following buffers can usually be entered with "Auto-enter a buffer".

Standardizing and Measuring pH

1. Immerse the electrode in a buffer and stir moderately. The meter displays the current pH measurement.
2. Allow the electrode sufficient time to reach equilibrium.
3. Press **Standardize**, then press either **1) Auto-enter a buffer** or **2) Manual buffer entry**.
4. Follow the prompts on the display.
5. The meter waits for a stable signal, automatically recognizes the buffer (if using "Auto-enter"), checks the electrode and buffer and enters the buffer. The entered buffer appears in the display.
6. Alternatively, if the signal is not stable, you can press **Enter** when the reading stabilizes according to your tolerance criteria. The meter then enters the buffer.
7. Repeat steps 1 through 4 to enter a second, third, fourth or fifth buffer. With more than one buffer the meter performs a diagnostic check on the electrode. The electrode is considered good if the slope is between 90 to 105%. If a sixth buffer is entered, the buffer farthest away is replaced by the new buffer.

Hints to achieve better accuracy:

- During standardization, allow time for the electrode to stabilize before entering the buffer into the meter.
- Standardize using at least two buffers, bracketing the expected pH of your samples.
- Standardize at least daily for the most accurate readings.
- Open the Fill Hole on the electrode.
- Stir all buffers and samples.
- Rinse the electrode with DI water between samples and buffers.
- Always use fresh buffers.

Clearing Buffers

Press **Standardize**, then press **3) Clear buffers** to clear buffers. If all previously entered buffers will be re-entered, it is not necessary to clear buffers since the meter will replace the previous values. If re-entering only some buffers, all the old buffers should be cleared.

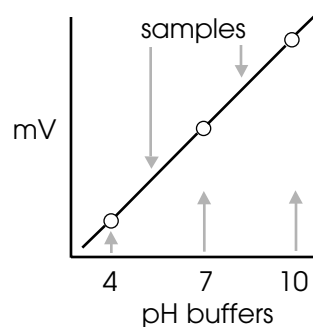
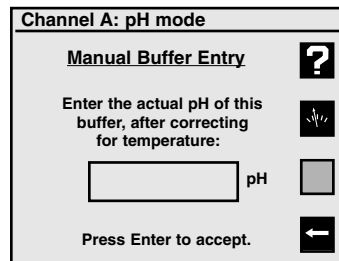
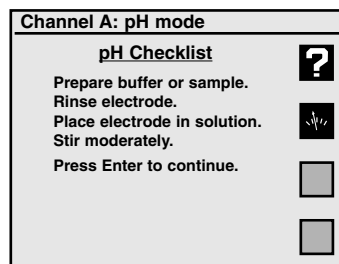
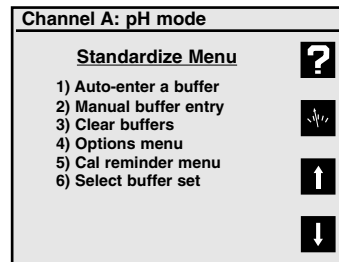

mV Mode

Millivolt measurements are used to measure ORP (oxidation-reduction potential) or redox potential, to check performance of pH or Ion Selective Electrodes, and for redox titrations.

The meter will measure millivolts (mV) by pressing **Mode** and selecting **2) mV**. Relative mV can be measured by entering a mV offset or using the current mV value as the mV offset.

mV Standardization Menu

In mV mode, press **Standardize** and the mV mode Standardization Menu appears:

1. **Auto-enter mV offset:** use to set the relative mV offset equal to the current mV reading. The current mV becomes 0.0 relative mV.
2. **Set mV offset:** use to manually enter a mV offset.
3. **Clear mV offset:** use to clear any offset that has been entered, returning the meter to absolute mV mode.
4. **Options menu:** a menu of additional settings specific to the mV mode. See below.

mV Mode Options Menu

1. **Select resolution:** use to set mV readings to 1 or 0.1 millivolt resolution.
2. **Select stability criteria:** use to select stability criteria for slow, medium or fast response which use a tight, average or loose requirement to indicate a "stable" (**S**) reading.
3. **Select signal averaging:** use to set the meter to average readings that are very slow (10 readings), slow (8), medium (6), fast (4) or very fast (2).
4. **Set standardization delay:** use to set a length of time for the meter to wait before entering a relative mV standardization.
5. **Set mV offset:** use to manually enter a mV offset (same as in the mV Standardize menu).
6. **Standardization menu:** returns to the mV Standardization Menu.

Clearing Relative mV Mode

Press **Standardize**, then press **3) Clear mV offset** to clear offset and return the meter to absolute mV mode.

Redox Titration

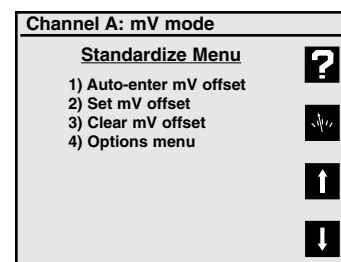
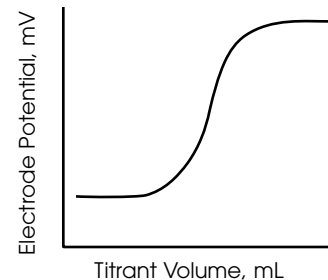

Standardize

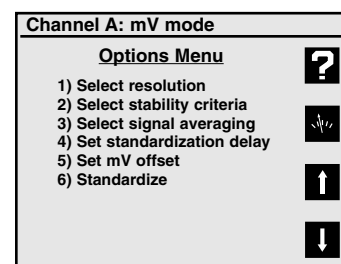

Quick Start Guide for Ion Measurements

1. Connect the Ion Selective Electrode (ISE) and Reference Electrode, if required, to the meter. "Combination" ISE's have a reference electrode built-in, and do not require a separate reference electrode or connection.

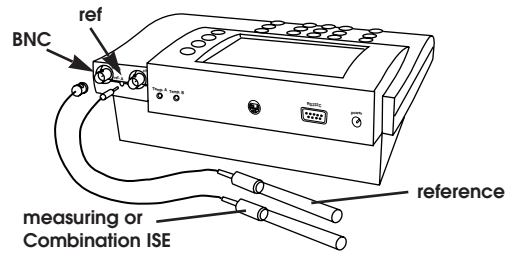

2. Prepare two or more ion standards at concentrations bracketing typical sample solutions. Add the appropriate Ionic Strength Adjuster solution to each standard.

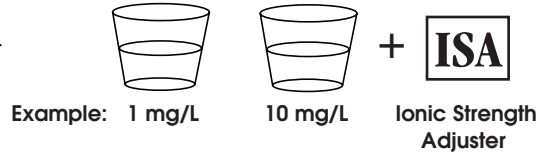

3. Set the meter to display the correct channel (the channel with the ISE attached, either A or B) using **Channel**. Set the meter to Ion mode: press **Mode**, then **3) Ion**.

Note: The meter will display "—" (no valid data) until an ion standard has been entered.

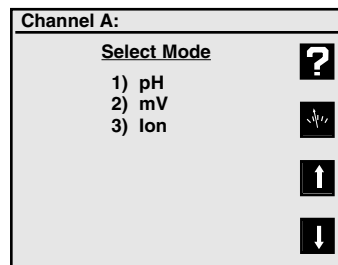

● Mode

● Channel

4. Place the electrode(s) in the standard, provide stirring (a magnetic stirrer is recommended), and allow sufficient time (1 to 5 minutes depending on the ISE) for the electrode to reach a stable signal.

5. Press **Standardize**, **1) Enter a standard** and follow the prompts to enter an ion name and units. Custom ion names can be scrolling up or down to **Custom** in Select Ion Name. Repeat these steps to enter up to seven ion standards. See the Standardizing and Measuring Ion section for more information.

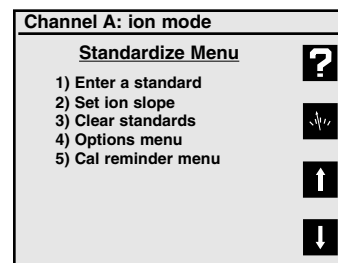

6. Check the ISE response by pressing **Cal Data** to see the standards and the ISE slope between calibration points (standards). The meter will allow an ion electrode slope between 5.92 mV/decade (10% slope) and 70.99 mV/decade (120% slope).

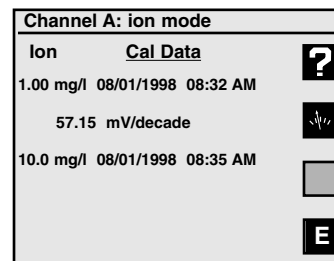

● Cal Data

Ion Mode

Ion Mode Standardization Menu

Select channel A or B. Press **Mode** and then press **3) Ion** for ion mode. Press **Standardize** and the Ion Mode Standardize Menu appears.

1. **Enter a standard:** use to add a new standard or update (re-enter) an existing standard. Follow the prompts. With the first standard you select the ion name and units. Use **Custom** to enter an ion name.
2. **Set ion slope:** use to manually enter a slope for the selected ion electrode. Used with a one-point ion calibration. Useful if the ISE has a known, stable slope, so that measurements can be made after entering a single ion standard.
Note: when two or more standards are entered, the meter uses the actual determined slope(s).
3. **Clear standards:** use to clear standards for the electrode standardization selected.
4. **Cal reminder menu:** use to set a timer reminding you to recalibrate. A **CALL** icon will appear on the main screen and an exclamation mark will appear beside the standards which need to be re-entered.
5. **Options Menu:** use to set various additional parameters to the ion mode. See below.

Ion Mode Options Menu

1. **Resolution:** use to set the readings to 1, 2, or 3 significant digits.
2. **Select stability criteria:** use to set the stability criteria to slow, medium or fast to match the electrode's speed and stability of response, providing tight, medium and loose requirements for a stable (**S**) indication.
3. **Select signal averaging:** use to set filtering of the electrode signal to very slow (10 readings), slow (8), medium (6), fast (4) or very fast (2). Slower settings give more stable readings, although may require longer times to reach stability.
4. **Set standardization delay:** use to set a reading delay time for the meter to wait before accepting an electrode signal during standardization. Programming a standardization reading delay helps slow responding electrodes reach equilibrium before the electrode signal is accepted. Delays of one minute for fast ISE's and five to ten minutes for slow ISE's are appropriate.
5. **Set ion slope:** use to enter a known ion electrode slope for a one point standardization.
6. **Standardize menu:** returns to the ion standardize menu.
7. **Manual temperature menu:** use to set a manual temperature for use in the absence of an ATC probe or when manually overriding the ATC.
8. **Data alarm menu:** use to enter ion limits to be entered. If the limits are exceeded an alarm indication ("*") is displayed.
9. **Set isopotential point:** use to enter an isopotential point. See page 20.
0. **Enable incremental:** use to turn on the known addition/subtraction type ion methods. See page 17.

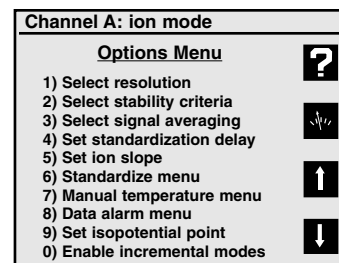
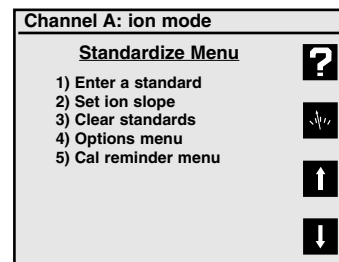

Standardizing and Measuring Ion

Standardizing and Measuring Ion

1. Set the meter to ion mode (use **Mode**) and turn ON the channel (use **Channel**) with the Ion Selective Electrode (either Channel A or B).
The meter displays “— — —”, indicating no valid measurement, until at least one ion standard has been entered.
2. Prepare a standard, and add the appropriate Ionic Strength Adjuster (ISA) solution to the standard.
3. Immerse the electrode(s) in the solution and stir continuously.
4. Press **Standardize**, select the correct channel if prompted to do so, and select **1) Enter a standard** to add a standard. If this is the first standard to be entered, select the ion name and units.

Follow the prompts. Be sure to allow enough time for the electrode to reach a stable signal.

Note: The default standardization delay for ion mode is 30 seconds. This can be set by the user. See Ion Mode Options Menu, page 15.

5. The meter waits for a stable signal and enters the standard. The entered standard appears in the display (in single channel mode). Alternatively, if the signal is not stable, you can press **Enter** when the reading stabilizes according to your tolerance criteria. The meter then enters the standard.
6. Repeat steps 2 through 5 to enter additional standards. Up to seven standards can be entered. With more than one standard, the meter performs a diagnostic check on the electrode.

Helpful Hints:

- Provide stirring.
- Allow the electrode time to reach a stable reading before entering the standard into the meter.
- To achieve better accuracy, standardize using at least two standards, bracketing the expected range of your samples.
- Standardize from low to high concentrations.
- Always use fresh standards.
- Use standards and samples near the same temperature.
- Remember to add Ionic Strength Adjuster to each standard and sample.

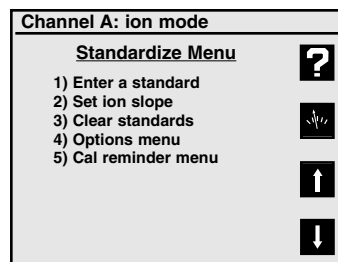
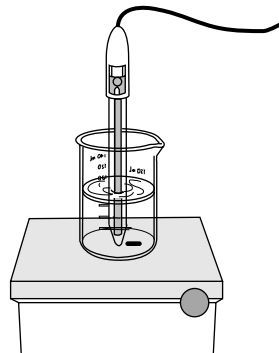
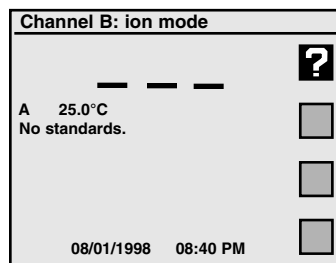

Standardize

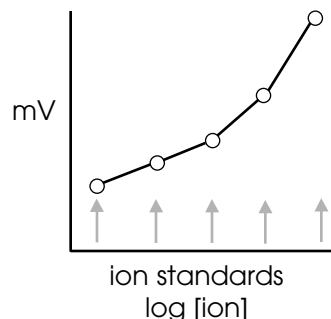
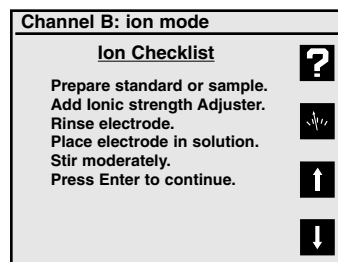

Measuring Ion using Known Addition type (Incremental Ion) Methods

The meter provides known ("standard") addition/subtraction and analate ("sample") addition/subtraction incremental methods for measuring ion concentrations. These advanced ion measurement techniques are useful in overcoming certain problems in ion analysis.

In known addition/subtraction a volume of sample is obtained, Ionic Strength Adjuster is added, and the ion electrode potential is obtained. Then a small volume of standard is added to the sample, and a second electrode potential is obtained. From the change in electrode potential, the ion concentration in the sample can be calculated. Interference from complexation and other ions can often be overcome by the known (standard) addition method.

In analate addition/subtraction the ion electrode is placed in a volume of standard and the potential obtained. Then a small volume of sample is added and a second electrode potential is obtained. This method helps overcome problems from widely differing sample ionic strengths or temperatures.

Enable Incremental Ion Modes

Press **Standardize**, select the channel (if necessary), **4) Options menu, 0) Enable incremental modes, then 1) Yes.**

This will "turn on" a special softkey in the main measure screen which is a direct access softkey to start a known addition type measurement.

Using a known addition type incremental ion measurement

Press the incremental method softkey, select **1) Known (standard) addition** or **2) Analate (sample) addition**. Follow the prompts to place the electrode in the first solution and obtain a reading, add an aliquot (a known volume) of standard or sample, obtain a second electrode reading, and enter the sample volume and standard volume and concentration. The meter then displays the calculated ion concentration in the original sample. Press **Enter** to leave the result screen and return to the measure screen to use direct reading ion measurements or start another known addition type measurement.

Channel A: ion mode	
Enable Incremental Modes	
Display ion soft key?	
1) Yes	
2) No	
If incremental modes are enabled, a '+/- ion' softkey will appear on the measurement screen.	

Select Measurement Technique	
1) Known (standard) addition	
2) Analate (sample) addition	
Select 'known addition' to add a small volume of known standard to the sample.	
Select 'anilate addition' to add a volume of sample to a volume of known standard.	
The meter will automatically detect subtraction techniques.	



Channel A: Known addition mode	
Incremental Ion Measurement	
S 58.7 mV	
Prepare sample and note volume.	
Add Ionic Strength Adjuster.	
Rinse electrode.	<input type="checkbox"/>
Place electrode in solution.	
Stir moderately.	<input type="checkbox"/>
Press Enter to accept.	

Channel A: Known addition mode	
Incremental Ion Measurement	
S 95.2 mV	
Delta = 36.5 mV	
Add aliquot of known standard.	
Stir moderately.	
For best accuracy, add volume until Delta > 4.0 mV.	<input type="checkbox"/>
Note total volume added.	<input type="checkbox"/>
Press Enter to accept.	

Quick Start Guide for Conductivity/Resistivity/Salinity/TDS Measurements

1. Connect the conductivity/ATC cell to the meter.

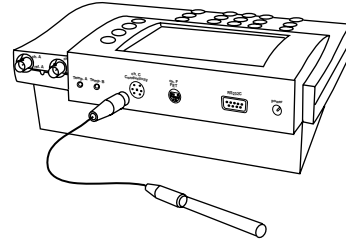

Conductivity/ATC cell

2. Prepare one or more conductivity/resistivity standard solutions at values near typical sample solutions.

3. Set the meter to display channel C using **Channel**. Set the meter to the correct mode (Conductivity, Resistivity, NaCl salinity, Practical salinity or Total dissolved solids) using **Mode**.

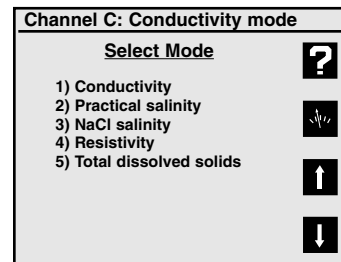

4. Place the conductivity cell in the standard, immerse the cell past the fill vent hole, then lift and allow the solution to drain out. Immerse and drain at least three times to fully flush the inner chamber of the cell. Gently tap the cell to dislodge any air bubbles.

5. Press **Standardize**, then **1) Enter a standard** and follow the prompts to enter the value of the standard. Repeat these steps to enter up to five conductivity/resistivity standards. Each standard is displayed in the main measuring screen when in single channel display.

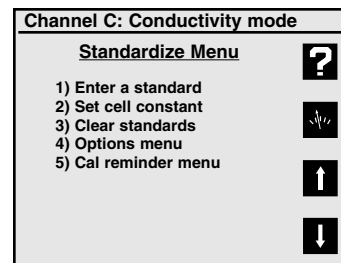

6. Check the cell performance by pressing **Cal Data** to display the standards and the cell constants between standards.

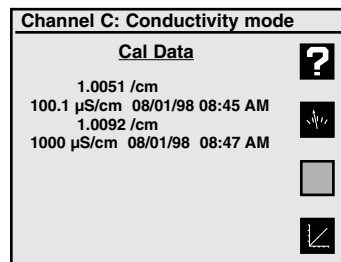

Conductivity/Resistivity/Salinity/TDS Menu

Conductivity/Resistivity/Salinity/TDS Standardize Menu

Turn ON Channel C using the **Channel** key. Press **Standardize** and the Standardize Menu is displayed.

1. **Enter a standard:** use to enter or re-enter a conductivity standard. Follow the prompts.
2. **Set cell constant:** use to manually enter a known conductivity cell constant for use with no standards. If the cell constant is known and stable, then this allows standardizing the cell without using standard solutions. If a standard is entered, the actual cell constant is calculated and used.
3. **Clear standards:** use to clear all existing standards. This is useful if new standards are to be entered.
4. **Options menu:** accesses additional settings used with each conductivity-type mode. See below.
5. **Cal reminder menu:** use to set a timer reminding you when to recalibrate. A **CAL!** icon appears on the main screen and an exclamation mark appears beside those standards which need to be re-entered.
6. **(TDS mode only) Calculate solids factor:** use this to allow the meter to calculate a solids factor. *
7. **(TDS mode only) Set solids factor:** use to manually enter a known solids factor * for a particular sample type.

* The "solids factor" is used to correlate the conductivity measurement with the weight based TDS measurement for a sample type.

Conductivity Mode Options Menu

1. **Select resolution:** use to set readings to 1 through 4 significant digits resolution.
2. **Select stability criteria:** sets stability criteria used to determine when the meter indicates Stable **S**.
3. **Select signal averaging:** use to set filtering of the cell signal to very slow (average 10 readings), slow (8), medium (6), fast (4) or very fast (2 readings). Slower settings give more stable readings, and are recommended with conductivity measurements.
4. **Set standardization delay:** use to set a reading delay time used by the meter when entering conductivity standards. Programming a reading delay helps by ensuring sufficient time for the cell signal to become stable before being entered into the meter.
5. **Set cell constant:** use to manually enter a known conductivity cell constant. (Same as in Standardize Menu).
6. **Standardize Menu:** use to return to the Standardize Menu.

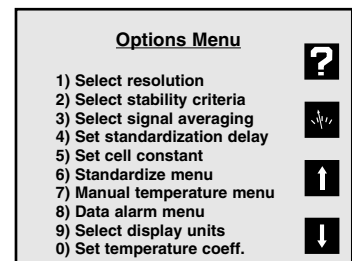
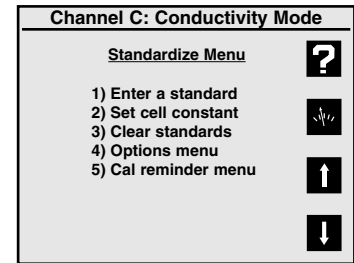

Conductivity/Resistivity/Salinity/TDS Modes

7. **Manual temperature menu:** Use to set a manual temperature for use in the absence of an ATC probe or when manually overriding the ATC.
8. **Data alarm menu:** use to set ion limits to be entered. If the limits are exceeded an alarm indication ("*") is displayed.
9. **Select display units:** the meter automatically switches between uS/cm and mS/cm in conductivity, or between ohm-cm, Kiloohm-cm and Megohm-cm in resistivity. If it is better to display a fixed unit, the "Fixed" settings allow that.
10. **Set temperature coefficient:** use to set the reference temperature to correct all conductivity and TDS measurements to, and set the temperature coefficient for the temperature correction. Salinity measurements by definition are corrected to 20°C. Resistivity measurements are not temperature corrected.

Standardizing and Measuring Conductivity/Resistivity/Salinity/TDS

1. Set the meter to display channel C (use **Channel**). Set the meter to the correct mode (Conductivity, Resistivity, NaCl salinity, Practical salinity or Total dissolved solids) using **Mode**.
2. Place the conductivity cell in the standard, immerse the cell past the fill vent hole, then lift and allow the solution to drain out. Immerse and drain at least three times to fully flush the inner chamber of the cell. Gently tap the cell to dislodge any air bubbles.
3. Press **Standardize**, select the channel if necessary, then **1) Enter a standard** and follow the prompts to enter the value of the standard. Repeat these steps to enter up to five conductivity/resistivity standards. Each standard is displayed in the main measuring screen when in single channel display. Use multiple standards that cover the range of values expected in samples. Generally, standards should be a factor of ten apart in conductivity.

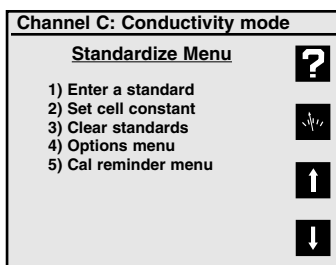
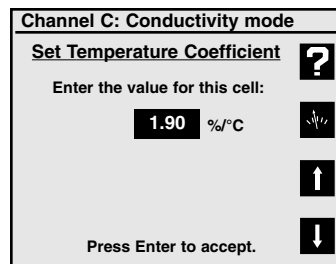
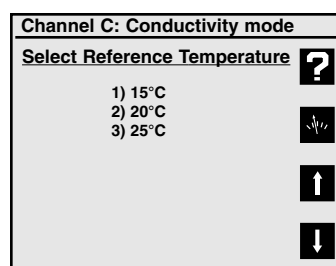
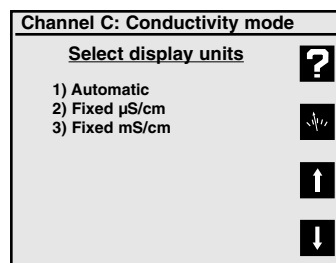

Quick Start Guide for Coulometric Karl Fischer Titration

- Turn Titrator 1 on for active display using the **Channel** key (see Function keys). If a Titrator is selected for single channel display, a real-time titration curve will be displayed during each titration.
- Select the KF titration protocol to be used for your analysis by pressing **Mode**, and selecting the closest protocol to your needs. Modify the selected protocol by pressing **Standardize** and selecting each parameter to modify.
- Obtain the sample to be analyzed, typically in a syringe if a liquid. Place the syringe on a balance and either note the weight or tare the balance to show zero.
 - Press the **Titration** softkey (the key with an icon beside it that looks like the KF titration cell).
 - Select which Titrator to use if there are multiple channels turned on for display.
 - Enter the weight of the container (syringe) and sample and press **Enter**. Usually this is entered as zero.
 - Immediately add the sample to the cell, usually by injecting the sample through the septum into the sealed cell. Carefully allow a final drop to fall off the needle with or for injected samples, and pull back slightly on the syringe after the desired sample volume has been introduced. Carefully remove the syringe from the cell.

Note: You must begin adding sample before the sample introduction time elapses, or the Titrator may end the titration before you add the sample. The sample introduction time can be programmed.
 - Place the container (syringe) back on the balance and obtain the weight. Enter the "empty container weight" (if you used zero for the "full container weight", then use a negative value for the second tare weight) and press **Enter**. This second weight must be less than the first weight.
 - Watch the titration progress. When the titration completes there is a beep, the status changes from "Titrating" to "Done" then to "Ready to titrate". A checkmark symbol beside the "T1" channel indicator means the titration is done. The result is automatically printed out the printer/computer serial port and stored in the Data Log.
- Repeat the titration. Usually KF analyzes use the average of two or three titrations for better accuracy. Once you have more than one titration result on a sample, the Controller will calculate statistics on the results. Press Cal Data, Select Channel if necessary, and press the X-bar Statistics softkey. The average, standard deviation and other statistical information is displayed for the selected Titrator, for the most recent "N" number of analyzes with the current units. Press Clear or the Graph softkey to return to the reagent condition bar graph screen, or press the Measure softkey to return to the main measure screen.

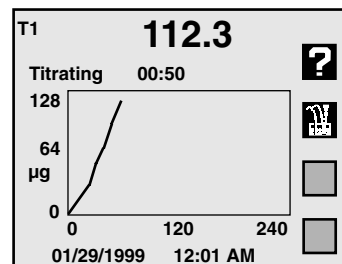
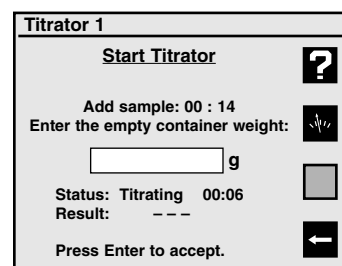
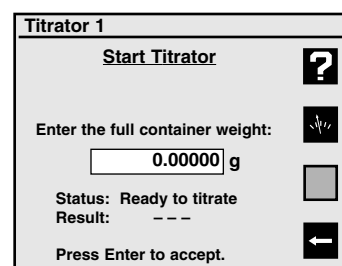
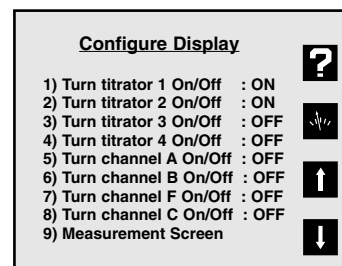

Karl Fischer Titrator Setup

The Model 260 and 270 Titration Controllers operate one to four attached Coulometric Karl Fischer (KF) Titrators. Each Titrator operates independently, so up to four KF titrations can be run simultaneously. The Coulometric KF method is a sensitive and specific method for the determination of water at low levels. Samples are introduced into a sealed titration cell where the water in the sample undergoes a chemical reaction (the Karl Fischer reaction) with the KF reagent in the cell. The Titrator senses that water is present and passes a quantity of electricity ("coulombs") through the cell to electrochemically generate iodine, which reacts with water. The Titrator determines when the titration is complete (all water has been consumed).

Preliminary Titrator Setup - Setting up and Connecting the KF Titration Cell

1. **Important!** If unpacking the Titration Cell, remove the shipping spacer between the platinum outer electrode and the glass frit.
2. Make sure the Titration Cell is clean and **DRY**. If the cell is dirty, especially the glass frit in the Generator Assembly separating the anode and cathode, it must be thoroughly cleaned and dried before filling being put in service. See Cleaning the Cell.
3. Prepare the Desiccant Assembly used to prevent room water vapor from entering the cell. Remove the Parafilm wrap over the ends used for protection during shipping. If needed, to replace the desiccant unscrew the Desiccant Assembly from the cell top, place a plug of cotton or glass wool in the tube bottom, fill the tube with dry Indicating "Drierite" or 4A molecular sieve desiccant (like "KF Dri-Alert") and close the top cap. Replace the Desiccant Assembly on the cell.
4. Insert the Dual Platinum element KF Indicating Electrode into the compression fitting cap with the open hole in the top of the cell. Make sure the two platinum rods are straight and not touching each other, and are clean. Carefully insert the electrode down until the rods nearly touch the cell bottom. Tighten the fitting firmly.
5. Carefully place a 5/16" X 1" magnetic stir bar in the cell.
6. Use a Teflon sleeve on the ground glass joint of the Generator Electrode or apply a high-vacuum stopcock grease to the joint.



Warning!

Failure to use either stopcock grease or a Teflon sleeve may result in the glass joint freezing together causing breakage.

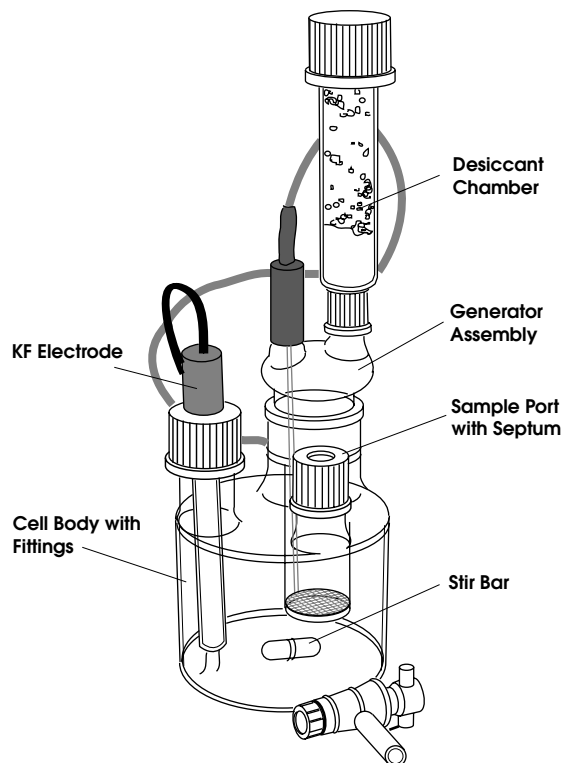
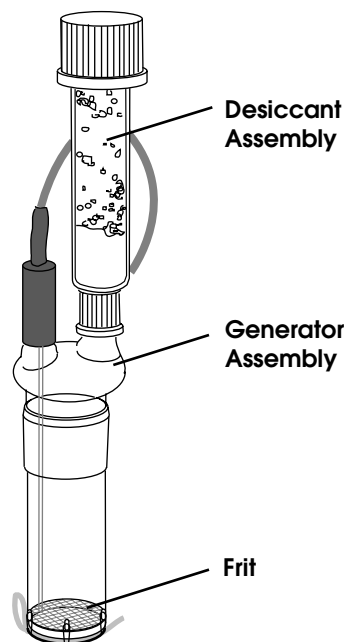

Karl Fischer Titrator Setup

7. Add 150 mL of the analyte reagent into the outer cell compartment. The reagent to use varies with sample type, but typical reagents include Hydranal Coulomat AG, AG-H, A or AK; EM Science AquaStar Coulomat AN, A or AK; or GFS Watermark Coulomat A.
8. Quickly place the Generator Electrode into the cell to prevent further water vapor absorption by the reagent.
9. Add 5 to 10 mL of the catholyte reagent to the inner chamber of the Generator Electrode by unscrewing the Desiccant Assembly and adding the reagent. Generally, the outer and inner reagent liquid levels should be even. Immediately replace the Desiccant Assembly. The catholyte reagent to use generally matches the analyte reagent used, such as Hydranal Coulomat CG, C or CK; EM Science Coulomat CN, C or CK; or GFS Watermark Coulomat C.
10. Place the Titration Cell in position on top of the Titrator.
11. Plug the Generator Electrode (phone plug) into the "Generator" connector on the back of the Titrator.
12. Plug the Indicator Electrode (dual pin plugs) into the "Indicator" jacks on the back of the Titrator.

Preliminary Titrator Setup - Connecting the Titrator(s) and Controller

1. Place the Titrator(s) beside the Controller. Connect the serial cable to the Controller connector "titrator network" and to the first Titrator ("Titrator 1") connector marked "network in". If more than one Titrator is connected, connect the second Titrator ("Titrator 2") by connecting a serial cable between Titrator 1 "network out" and Titrator 2 "network in". Connect up to four Titrators by daisy-chaining in this fashion.
2. Plug the 3-pin DIN power connector into each Titrator, and plug the line cord(s) from the transformer(s) into wall outlets. Plug the power connector for the Model 260/270 Controller into the back of the Controller where marked "power", and plug the transformer into a wall outlet.
3. Verify the Titrators are communicating with the Controller by turning on the Titrator channel for each attached Titrator. Press **Channel**, then press the number for each titrator channel to toggle the channel ON, then press the number key for **Measurement screen**.
4. With the Titrator(s) and Controller set up, the Titrator(s) will automatically begin drying the cell and reagents. When the cell and reagents are dry, the solution should be pale yellow. If the solution is dark yellow to brown, it is overdry; add a very small quantity of water to the reagent until it goes colorless.

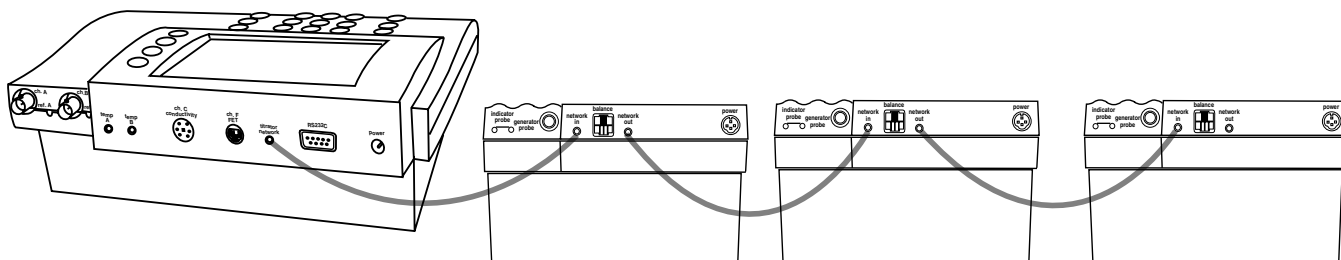

Karl Fischer Titration Mode

Running a Titration

1. Select one or more titrator channels for active display by pressing **Channel** and pressing the number key for each titrator channel to toggle ON or OFF. When all channels have been set, press the number key for **Measurement screen** or press the **Measure softkey** (the softkey with the meter and needle symbol).
2. Press **Mode** and select one of the 10 stored KF titration protocols (protocols are methods) to use for the selected Titrator. If multiple channels are active, Select the Titrator to change mode (protocol).
3. Modify the protocol if necessary by pressing **Setup, 4) Titration setup menu, 1) Modify titration protocol**, and select the protocol. Any changes made to this protocol are immediately stored for the protocol and are automatically sent to all Titrators using that specific protocol. The Titrators using any given protocol are displayed at the top of the screen.
4. Press the Titration softkey to start the titration. If multiple titrators are turned on, select the titrator to start.
5. If micrograms or milligrams water are the units, the Add sample reminder and countdown will begin and the titration start immediately. After adding the sample press Enter.
If % or ppm water are the units, enter the weight for the sample and container (usually a syringe). Type in the weight value, or use automatic transfer from a balance, then press Enter. Common practice is to tare the balance with the sample/syringe on it, and enter this weight as zero.
6. Immediately add the sample to the cell. The Controller will display "Add sample: 00:20" and countdown the programmed sample introduction time. Be sure to begin adding the sample within this time period, or the Titrator may end the titration before the sample is added to the cell.
7. If % or ppm are the units, enter the empty container weight. If the balance was tared with the syringe and sample, when the syringe is placed back on the balance the weight is displayed as a negative value. Enter this negative value using the \pm key. If weight transfer from a balance is set up, the weight appears in the display automatically, just press Enter.
8. The Controller returns to the main measure screen. In single channel display, a full screen real-time titration curve is displayed, showing the progress of the titration. In multiple channel mode there is no titration graph. The status of the Titrator is displayed ("Titrating"), and when the titration is complete the status changes to "Done" briefly, then a "checkmark" appears by the titrator channel indicator to show the titration is done and the data is ready. The status changes to "Ready to titrate", or the appropriate status.

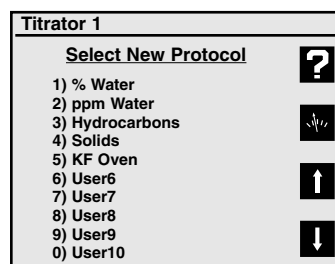
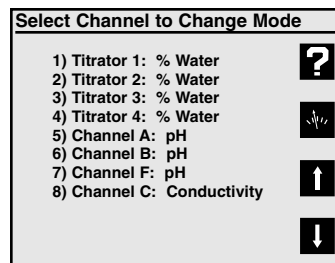

Karl Fischer Titration Mode

Titration Status and Operating Data

Press Cal Data, select the Titrator if displaying multiple channels, to see that Titrator's current operating data, including status, current result, background drift rate, and reagent condition.

Background drift rate is an important parameter to monitor. It is also displayed for each titrator in the main measure screen. If the Titration Cell is sealed well to prevent ambient water vapor from entering the cell, and if there are no Karl Fischer reaction byproducts or sample components that are causing side reactions in the cell, then the background drift rate should be a low

measure screen. If the Titration Cell is sealed well to prevent ambient water vapor from entering the cell, and if there are no Karl Fischer reaction byproducts or sample components that are causing side reactions in the cell, then the background drift rate should be a low number, typically less than 6 ug/min. The best results will be obtained when the background drift rate is low and stable. For maximum accuracy, the Titrator automatically subtracts the background drift from the titration result throughout the titration. Large drift rates may be reduced by checking the desiccant, the cell seals and joints, cleaning the cell and replacing the reagents.

Reagent condition is indicated by the titration current, displayed in milliamps (mA), and shown by the bar graph. The marks on the bar graph indicate the full current obtained with fresh reagents of the AG/AN, A or AK types. As the reagents become exhausted the current will decrease and titrations will take longer. At 90 mA the error message "Reagents exhausted" appears, and reagents must be changed.

Statistics on the previous titration results are available by pressing the X-bar softkey. The average, standard deviation, Relative Standard Deviation, minimum, maximum and count (the number of data points used) are displayed. The number of values used, "N", can be set by pressing the N softkey. Many analysts use the average three KF titrations to increase their accuracy. Obtaining precise results, especially on a water standard, is a useful check on the analytical technique of the analyst. Good technique usually leads to repeatable, precise results with a low standard deviation.

Note: when using the average be sure to have the last "N" results for the selected Titrator are results from the same sample or standard. Example: if N is three, and only two titrations have been run on a sample, then the third previous result was from a different sample and the statistics will be not be correct!

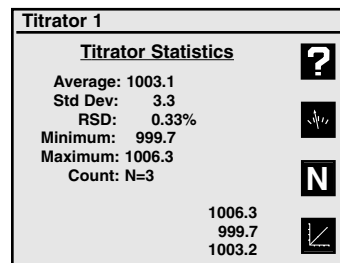
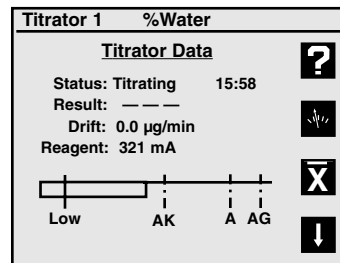

Karl Fischer Titration Mode

Titration Setup Menu

Press **Setup, 4) Titration setup menu** to access KF titration protocols, intermediate result printout, select balance type, and control the Titrator stirrers.

1. Modify titration protocol: use to modify the 10 stored KF titration protocols.
2. Select/assign protocol: use to select a protocol for a Titrator.
3. Print a protocol: use to print hardcopy of a stored protocol.
4. Set printouts on/off: use to turn on or off printing intermediate titration results out the serial port to a printer/computer. Useful for monitoring the rate of titrating water in a sample when developing the optimal protocol for a specific sample.
5. Set printout interval: use to set the time interval in seconds for printing intermediate titration results.
6. Select balance type: use to set the balance attached to Titrator 1 for automatic weight transfers. The output string of the balance must match the type selected in order for the Titrator to use the balance data.
- 7 -0. Turn stirrer 1 on/off: use to temporarily turn off a Titrator stirrer in order to replace the cell onto the Titrator and have the stirbar magnetically couple. The Titrators are designed to maintain an equilibrium in the cell, and so continuous stirring is required. All paused stirrers are automatically turned back on when this Setup menu is exited.

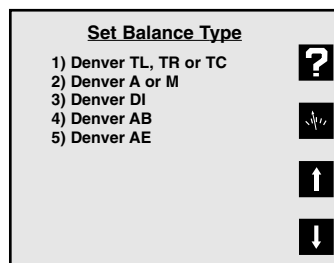
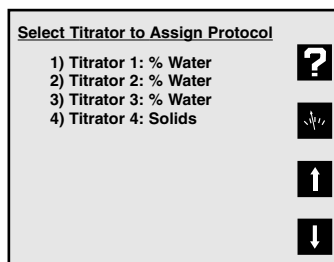
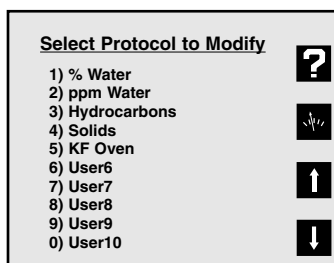
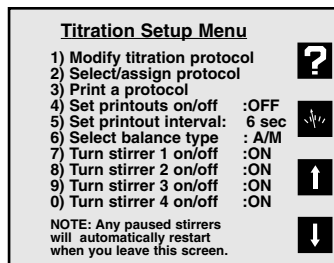

Cleaning the Titration Cell

General Cleaning

Various cleaning procedures are possible, with a general method consisting of washing the cell with a detergent solution, rinsing with de-ionized water then rinsing with methanol or acetone. Sometimes, the frit or diaphragm must be cleaned more vigorously by drawing reagents through the frit by applying a vacuum to the inner chamber of the cell.

Cleaning the diaphragm/frit

1. Block the hole in the upper glass portion of the Generator Assembly, this is where the platinum wire goes from the inside to the outside of the assembly. A recommended method is to wrap a piece of Parafilm around the Generator Assembly. When covering the hole be sure that the wrap is not long enough to reach the solvent level as the vacuum created can pull liquid between the Parafilm and the generator and in through the wire hole.
2. Have a vacuum source available. One method is to use a vacuum aspirator.
3. Attach the aspirator to a faucet and connect the Generator Assembly to the aspirator. (See Diagram)
4. Place the Generator Assembly into a beaker of the appropriate solvent that the samples analyzed are known to dissolve in. Typical solvents include methanol, acetone, chloroform and toluene.
5. Apply the vacuum and draw the solvent up through the frit.
6. Repeat until the frit appears to be clean. This includes the removal of any discoloration that may have accumulated from sample analysis. The solvent being drawn through should appear clear and clean, the absence of an oil layer in the solvent drawn through or any precipitate on the frit, and are indications the frit is clean. The solvent is drawn through the frit easier.
7. More than one reagent may be drawn through the frit for cleaning purposes.
8. The last solvent to be drawn through the generator assembly should be either methanol or acetone.
9. Final cell drying should be done in an oven at 50° C-80° C for 1-2 hours.



Warning!

**Do not heat the Generator Assembly above 80 C.
Damage will result.**



Caution!

Let the cell cool before filling it with fresh Karl Fischer reagent, which is mostly methanol and is flammable!

Cleaning the Titration Cell

10. Place fresh coulometric Karl Fischer reagents in the cell and Generator Assembly, place the cell on the Titrator and begin the automatic cell and reagent drying process. It may take a newly cleaned frit some time for reagent to diffuse into the frit and provide full titration current.
11. If the above procedure does not clean or unclog the glass frit, it may be necessary to use strong cleaning agents. For severely clogged frits, a chromic acid or concentrated nitric acid cleaning process is recommended.



Caution!

These are strong acids and must be used with appropriate care and protection!

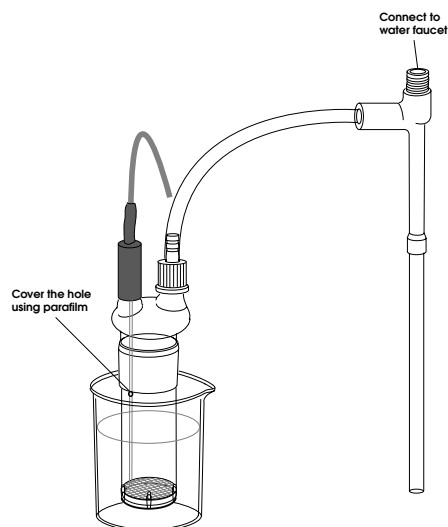

Reagent Selection

Coulometric Karl Fischer reagents are available from several manufacturers, including Riedel-de Haen Hydranal, EM Science AquaStar and GFS Watermark. The reagent is chosen so that its polarity will dissolve the samples. The most common reagent type is the "AG" or "AN" methanol based, next is the non-polar chloroform or long-chain alcohol based "A", "AG-H" types for oils and other hydrocarbons, and samples with ketones or aldehydes must be run in the special ketone reagents "AK". Contact Denver Instrument Electrochemistry Technical Support, or the various reagent manufacturer's Technical Support for additional assistance.

Balance interface

Weight based measurements are the most accurate, and using a three or preferably four place balance is recommended. Automatic weight transfer from the balance to the Titrator is a fast, error-free way to enter weights. The Titrator supports most Denver Instrument balances. The balance is attached to the balance port on Titrator 1, and serves for all Titrators. The balance type must be set in the Controller, and the balance must be set to 4800 baud, parity off, continuous once per second output. For exact settings for each Denver Instrument balance, contact Technical Support at 800-321-1135.

Troubleshooting Karl Fischer Titration

Common Errors and Solutions

Indicator error

- Check the KF electrode (dual platinum) to see if it is plugged in.
- Check that the platinum tips are not touching each other or the cell.
- Check for crack(s) in the electrode.
- Verify that the reagents are not overdry (dark in color).
- Clean the platinum tips thoroughly.

Generator error

- Check the Generator Assembly to see if it is plugged in at both ends.
- Check the platinum grid at the bottom of the Generator Electrode.
- Check for cracks in the glass around the black cable connection.

Drying reagents

- If there are bubbles rising in the Generator Electrode, it is drying. There is water trapped in the cell and it must be titrated before continuing.
- Add a small amount of Composite 5 reagent to the cell to help dry the cell more quickly.
- If it is not bubbling and the reagents are getting darker, unplug the module and controller and replug back in while adding a drop of water.
- If reagents smell like sulfur, dispose of them. The cell then needs to be cleaned and dried in an oven (See Cleaning Instruction).

Overdry

- Add a drop of water.
- Keep adding a drop at a time until the solution goes clear and Controller displays "Ready to titrate" or "Drying reagents".

Titration off-line

- Reconnect all serial cable connections.
- Verify serial cables go to correct connections ("in" and "out"). Press the **Titration** softkey, then select 6) 'reinitialize network'.
- Unplug power to the Titrators and Controller and replug them back in.

Stir bar not spinning

- Check to see that the module is plugged in.
- For further information contact Technical Assistance, a replacement motor kit may be necessary.

Low Results

- Verify after injecting the sample, no sample is left on the end of the needle prior to pulling it out.
- Change the desiccant and cotton, also inspect the septum and replace as necessary.
- Verify that the drift rate is normal (not high).
- Calibrate balance.
- Clean the cell and frit.
- Replace reagents.

High results

- Verify that when injecting, that all of the sample was injected into the reagents and not on the side of the reaction cell.
- Verify that the drift rate is normal
- Check all seals on the reaction cell, and secure as needed.
- Calibrate the balance.
- Clean the cell and frit.
- Replace reagents.

Modifying Titration Protocols

Each Titrator runs one of the 10 stored protocols. The protocol controls all parameters of the titration, including the units, sample introduction time, sample extraction time, endpoint persistence time, endpoint slope, and a solvent blank.

Stored protocols include typical titration protocols for measuring water content in easily analyzed liquid samples in % and ppm units, for measuring water in hydrocarbons, water in slower to release solids, and water in plastics being introduced by a KF oven/vaporizer. These protocols can be modified and renamed, and five additional protocols are available for users.

A generic protocol often provides good results, but occasionally must be modified for a specific sample. Examples of modifications include changing the time for a titration, either as additional "up-front" time with introduction time, or as additional post-endpoint time with persistence time, or using a low endpoint slope value like 0.05 to force a titration to continue longer.

1. Each protocol has a user-entered name.
2. Units of micrograms, milligrams, %, ppm, or mg/l can be selected. % and ppm are weight:weight water:sample. The mg/l unit is weight:volume.
3. Sample introduction time should provide ample time to get the sample into the cell. Sometimes a little extra time is helpful, and can be set.
4. Extraction time allows time for a slow dissolving, slow water releasing, or slow mixing sample to release water to the reagent system for titration.
5. Endpoint persistence time is additional time after first reaching the endpoint that the titrator continues to titrate; use to ensure complete recovery of water from difficult samples.
6. Endpoint slope is the primary endpoint control. The titrator will titrate until the set slope (rate of water recovery from the sample in micrograms water/second) is reached; use to ensure complete recovery of water from slowly releasing samples such as solids or crystalline materials. This has little effect on miscible liquid samples which usually release water quickly.
7. Use a solvent blank to subtract water present in a solvent used to dissolve otherwise insoluble solid samples. The sample is dissolved in a fixed volume of a solvent, then that solvent is injected into the cell. Determine the water content of the fixed volume of solvent in micrograms, then set that value as a blank to be subtracted.

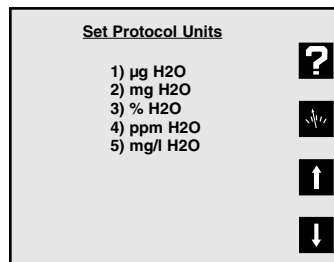
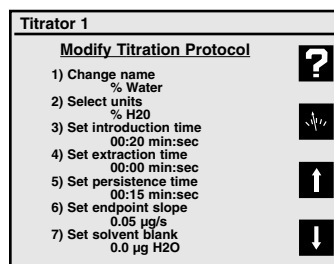

Data logging

The meter will store up to 620 data points in an internal data log. Press **Print** when in the main measure screen to store the current result with channel, stability, temperature, result, units, sample label, sample number, date and time in the data log. **Print** also outputs this data through the RS232 serial port. All channels displayed are printed and data logged.

Data Log Menu

Press **Data Log** and the Data logging menu will appear.

1. **View data log:** Shows the stored data, one screen at a time. Press the arrow soft keys to page up and down through the stored data. Press **Clear** or **Enter** to return to the menu.
2. **Data logging on/off:** Turns the data logging on or off for all displayed channels.
3. **Set logging frequency:** Allows you to enter the time interval for automatic data logging.
4. **Clear data log:** Clears all stored data points from memory.
5. **Set sample number:** Allows a number to be assigned to the first sample. This number will increment for each consecutive sample logged.
6. **Set sample label:** A custom user-entered name can be entered. This label will be printed and stored with all data. To enter a label, repeatedly press a number key to select the desired character, then press **Enter**. Repeat for all characters, then scroll up or down to "save and edit" and press **Enter**.
7. **Print data log:** Use to send all data points in the Data Log to the RS232 serial port.

Note:

Model 260 Titration Controller does not show all Data log menu items.



Warning

The Data log is kept in instrument RAM (Random Access Memory), which is powered by the external power supply. Removing power from the meter will lose the stored data in the Data log.

Note:

Meter settings and electrode standardization data are kept in separate non-volatile memory. Unplugging the meter has no effect on these stored items.

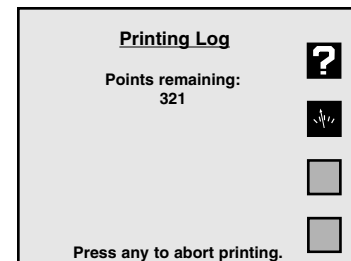
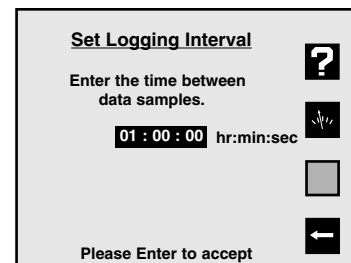
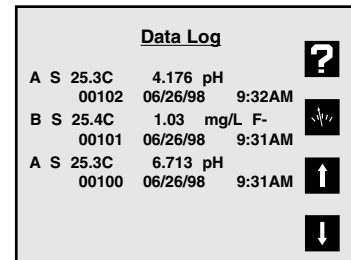
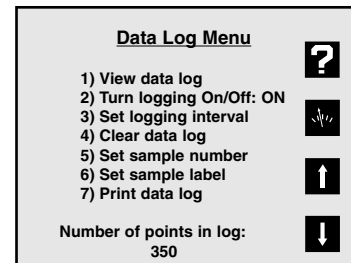

Troubleshooting

Testing the Electrode and Meter

To test the meter for correct operation without a pH, ORP or Ion Selective electrode, short the BNC input connector (either Channel A or B) using the BNC Shorting Cap that was supplied with the meter on the BNC connector(s). Select the correct channel using **Channel**. Select mV mode by pressing **Mode** and selecting **2) mV**. Verify meter is in absolute mV mode (display shows "mV", not "rel mV"). If the meter reads 0 ± 0.1 mV*, and is stable, the meter is measuring correctly.

To test the pH electrode, place it in a fresh pH 7 buffer. Select the correct channel for the electrode using **Channel**. Press **Mode** and select **2) mV**. Verify that the meter is in absolute mV mode (display shows "mV", not "rel mV") and note the mV reading. Repeat for either a pH 4 or pH 10 buffer. If the electrode potential is within the limits shown, it is measuring correctly.

pH 7	0 ± 30 mV
pH 4	159 to 186 mV higher than pH 7 reading
pH 10	159 to 186 mV lower than pH 7 reading

* **Note:** Meter accuracy is ± 0.1 mV at calibration temperature, not including long term drift and any temperature error. The zero and slope temperature coefficients of the meter over the range of 15 to 40°C specify 85ppm/°C, or ± 4 mV at full scale (worst case). The long term drift should not exceed 0.1 mV per month. This results in an expected range of 0 ± 0.3 mV with 1 minute stability of ± 0.1 mV at room temperature.

Meter Specifications

Models 215, 220, 225 and 250

Modes	pH	mV	Temperature
Range	-2.000 to 20.000	±1800.0	-5.0 to 105.0°C
Resolution	0.001/ 0.01 / 0. 1	0.1 / 1	0.1
Accuracy	±0.002	±0.1	± 0.3
Temperature Compensation	Automatic & manual: -5 to 105°C		
Slope Control	Automatic, 90 to 105% Manual, 80 to 120%		
Environmental Conditions	15 to 40°C, humidity from 0 to 90% (noncondensing)		
Power Requirements	115V 50/60Hz (Additional voltages available)		
Ordering Information			
Meter with kit includes:	Meter, power supply, high performance glass-body pH/ATC "3-in-1" electrode, electrode arm and operation manual.		
Meter only kit includes:	Meter, power supply, electrode arm and operation manual.		

Models 225 and 250

Mode	Ion
Range	1.00E-9 to 9.99E9
Resolution	1, 2, or 3 significant figures
Accuracy	± 0.17%n (n = ion charge)
Slope Control	Automatic or manual, 5.9 mV/decade (10% slope) to 71 mV/decade (120%)

Models 220 and 250

Mode	Conductivity	Resistivity	Practical Salinity	NaCl Salinity	TDS
Range	0.01 – 300,000 µS/cm*	30 - 20MΩ•cm*	0.01 - 42 ppt*	0.01 - 70ppt*	0.005 - 150,000*
Resolution	1, 2, 3, or 4 significant figures				
Accuracy	± 0.5% ±0.01µS/cm				
Cell Constant	Automatic or manual, 0.01 - 100 /cm				
Temperature Coeff	Off or On (0 - 4% /°C)				
Number of Standards	5				

*depending on cell constant (from 0.1 to 10 /cm)

pH Theory

The measurement of pH plays an important role in water quality, industry and research. pH is a measure of acidity or alkalinity of a solution, and is usually written:

$$\text{pH} = -\log [\text{H}^+]$$

Where $[\text{H}^+]$ is the concentration of hydrogen ions.

pH levels generally range from 0 to 14, with a pH value of 7 being the neutral point. pH values greater than 7 are alkaline, and pH values less than 7 indicate acidic solutions.

Conventional pH meters use a combination glass pH electrode, which includes a reference electrode. The reference electrode provides a stable reference point and completes the electrical circuit. The pH meter reads the voltage of the two electrodes, converts it to pH units, and displays the result.

These meters can also use a Field Effect Transistor (FET) pH/ATC electrode for measuring pH. The FET uses an ion-sensing solid state membrane attached to a transistor to measure the hydrogen ion concentration of a solution. These non-glass pH electrodes offer durability, dry storage and no glass construction.

The electrode signal varies with the pH, according to the Nernst Equation:

$$E = E^\circ + S \cdot \log [\text{H}^+]$$

Where:

- E = measured electrode potential
- E° = standard potential of the system (constant)
- S = slope

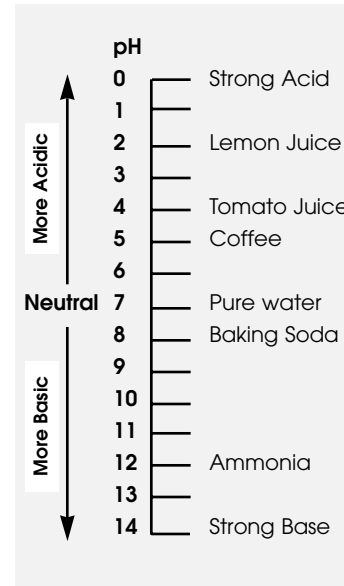

pH scale showing the relative acidity or basicity of some common substances

Ion Selective Electrode Theory

The measurement of ions plays an important role in water quality, industry, research and environmental monitoring. Ion-selective Electrodes (ISE's) respond, more or less exclusively, to a specific type of ion in solution. The particular ion to which an ISE responds depends on the chemical makeup of its sensing membrane. ISE's operate according to a form of the Nernst equation:

$$E = E_o + S \cdot \log [\text{ion}]$$

Determining the Isopotential Point

The Isopotential point is the potential of an electrode system which does not change with temperature. Typical pH electrodes have isopotential points near zero mV (which is the default setting for the meter). For high accuracy pH measurements, or for ion measurements where the sample temperature may widely vary, the isopotential of the pH or ion electrode may be experimentally determined and entered into the meter.

- Prepare a set of buffers or ion standards spanning the linear range of the electrode. Place the buffers or standards in a temperature bath at known temperature.
- Place the meter into mV mode.
- Measure and record mV readings of each pH or concentration, and repeat at several temperatures.
- Plot the log of concentration or pH value versus mV reading.
- Connect the points for each temperature.

Where the lines intersect is the Isopotential point.

Ion Electrode Isopotential Point

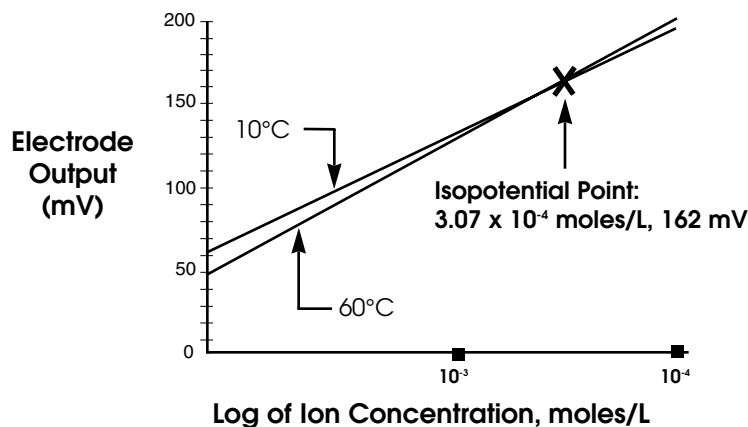

pH Electrode Isopotential Point

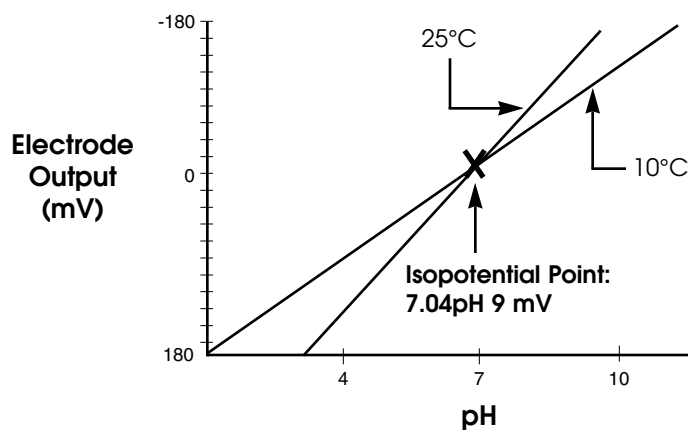

RS-232 Serial Interface Meter Command Set

The Denver Instrument Series 200 meters have a bi-directional RS-232 serial port, which can be used to send commands to the meter and output data from the meter. Special characters (Ω , μ , ϵ) are coded using ASCII (not ANSI); use an ASCII font like "Terminal". Also use a terminal emulation like TTY or ANSI, not VT100.

Serial commands follow either "keystroke" mode or high level command mode consisting of "SET", "GET" and "DO" instructions.

(Note: "GET" and "DO" are optional).

Keystroke instructions

KEYS	M	Mode
	Z	Standardize
	C	Cal Data
	H	Channel
	S	Setup
	L	Data Log
	R	Clear
	N	Enter/Print
	(0 to 9)	Equivalent to pressing a numeric key
	-	+/- key
	.	Decimal key
	E	Used within a number to enter values in exponential form
	!	Press softkey #1 (at top, usually Help)
	@	Press softkey #2 (usually return to measuring screen)
	#	Press softkey #3 (usually up arrow)
	\$	Press softkey #4 (at bottom, usually down arrow)

Notes: Key commands are acknowledged by the meter with a reply
Keys = COMMAND_RECEIVED. Multiple keys can be concatenated together into a single command, for example, Keys Z413@
(Standardize, options, resolution, set to 3, main), or Keys Z4721.2-N@
(Set manual temperature to -1.2).

High level instructions

Use commands SET, GET, DO.

Follow command by a keyword like MODE, STDZPH, STDZCONDO, CALDATA, STDZCLEAR, CHANNEL, DATETIME, TIMESTAMP, DISPLAY, READ, INFO
Typical Syntax: (command) (keyword) (channel) (variable(s))

Error conditions are replied to with an Error response; for example:

"Error: Need channel", "Error: Need mode", "Error: Unspecified"

Accepted commands have a response; indicated below for each command.

Mode operations

set mode "channel character" "mode id"

Examples: SET MODE A PH
 SET MODE B MV
 SET MODE B ION
 SET MODE C CONDUCTIVITY

Returns confirmation; for example "SET MODE A PH" returns "A mode = PH".
Valid modes are (depending on the meter model) PH, MV, CONDUCTIVITY, RESISTIVITY, PRAC_SALINITY, NAACL_SALINITY, DISSOLVED_SOLIDS.

RS-232 Serial Interface Meter Command Set

(get) mode "channel character" "mode id"

Examples: (GET) MODE A

Returns mode information on selected channel;
"A Mode = MV".

Channel operations

set channel "channel character" "on | off"

Examples: SET CHANNEL A ON
SET CHANNEL C OFF

Returns confirmation; for example "A Channel = ON".

(get) channel "channel character"

Example: (GET) CHANNEL B

Returns channel information; "A Channel = OFF".

(DO) READ "channel character" (Take reading w/temperature without sending to data log).

Standardization operations

(DO) STDZPH "channel character"

(DO) STDZCLEAR "channel character"

(DO) STDZCONDO "conductivity standard value"

(DO) CALDATA "channel character"

(DO) STDZPH A (Auto-enter a buffer)

Returns "Stdz pH = COMMAND_RECEIVED", followed by the Calibration Data printout.

(DO) STDZCLEAR A (Clear all buffers/standards.)

Returns "Stdz Clear = COMMAND_RECEIVED".

(DO) STDZCONDO 1000 (Enter a standard of 1000 uS/cm.)

Returns "C Stdz Condo = COMMAND_RECEIVED", followed by the Calibration Data printout.

(DO) CALDATA A

Returns "A Cal Data = COMMAND RECEIVED" followed by the Calibration Data printout.

General meter setup operations

SET DATETIME MM/DD/YYYY HH:MM:SS (Leading 0's required, 24 hour time)

(GET) DATETIME Returns: "MM/DD/YYYY HH:MM:SS"

(GET) INFO Returns Model, Version, Serial#.

(DO) DISPLAY display_text_string (at 0, 0) (x = pixel from left, 0 - 319)

(DO) DISPXY x y display_text_string (y = pixel from top, 0 - 239)

Example: DO DISPXY 15 0 Device ready, press any key.

SET TIMESTAMP # (Set date/time using 'unix' seconds)
(GET) TIMESTAMP

Maintenance

This product contains no user serviceable parts. All replacement parts should be obtained from the manufacturer or an authorized distributor.

Cleaning

The exterior surfaces of this product may be cleaned with a damp cloth or with mild detergent.



CAUTION

Changes or modifications not expressly approved by the manufacturer will void the user's warranty for this equipment.

Menu Tree Diagram

Mode (A, B & F)

- 1) pH
- 2) mV
- 3) Ion

pH Standardize Menu:

- 1) Auto-enter a buffer
- 2) Manual buffer entry
- 3) Clear buffers
- 4) Options menu
- 5) Cal reminder menu
- 6) Select buffer set

pH Options Menu:

- 1) Select resolution
- 2) Select stability criteria
- 3) Select signal averaging
- 4) Set standardization delay
- 5) Set pH slope
- 6) Standardize menu
- 7) Manual temperature menu
- 8) Data alarm menu
- 9) Set isopotential point

mV Standardize Menu:

- 1) Auto-enter mV offset
- 2) Set mV offset
- 3) Clear mV offset
- 4) Options menu

mV Options Menu:

- 1) Select resolution
- 2) Select stability criteria
- 3) Select signal averaging
- 4) Set standardization delay
- 5) Set mV offset
- 6) Standardize menu

Ion Standardization Menu:

- 1) Enter a standard
- 2) Set ion slope
- 3) Clear standards
- 4) Options menu
- 5) Cal reminder menu

Ion Options Menu:

- 1) Select resolution
- 2) Select stability criteria
- 3) Select signal averaging
- 4) Set standardization delay
- 5) Set ion slope
- 6) Standardize menu
- 7) Manual temperature menu
- 8) Data alarm menu
- 9) Set isopotential point
- 0) Enable incremental modes

Mode (C)

- 1) Conductivity
- 2) Practical salinity
- 3) NaCl salinity
- 4) Resistivity
- 5) Total dissolved solids

Conductivity Standardize Menu:

- 1) Enter a standard
- 2) Set cell constant
- 3) Clear standards
- 4) Options menu
- 5) Cal reminder menu
- 6) Calculate solids factor (TDS mode only)
- 7) Set solids factor (TDS mode only)

Conductivity Options Menu:

- 1) Select resolution
- 2) Select stability criteria
- 3) Select signal averaging
- 4) Set standardization delay
- 5) Set cell constant
- 6) Standardize menu
- 7) Manual temperature menu
- 8) Data alarm menu
- 9) Set temperature coeff.

Setup Menu:

- 1) Time and date menu
- 2) Select temperature units
- 3) Select contrast
- 4) Select baud rate [Model 215 - 250]
Titration setup menu [Model 260 - 270]
- 5) Setup serial port [Model 215 - 250]
Serial port menu [Model 260 - 270]
- 6) Keypress beep on/off
- 7) Select video color scheme
- 8) Show meter information
- 9) Enable measure lock
- 0) Enable strict calibration
- ±) Set screen saver timeout
- .) Restore factory defaults

Data Log Menu:

- 1) View data log
- 2) Turn logging On/Off :OFF
- 3) Set logging interval
- 4) Clear data log
- 5) Set sample number
- 6) Set sample label
- 7) Print data log

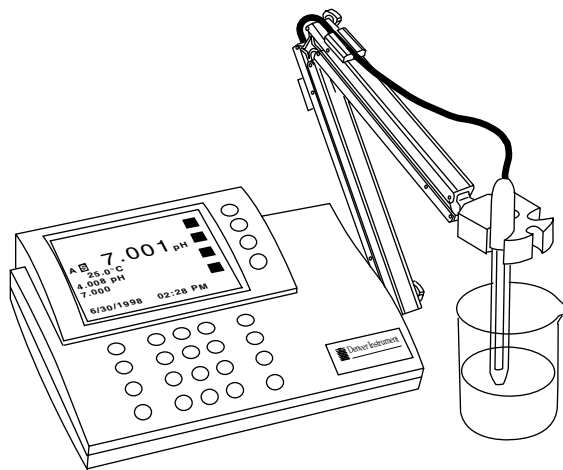

 **Denver Instrument Company**

6542 Fig Street • Arvada, Colorado 80004 U.S.A.
1-800-321-1135 • (303) 431-7255 • Fax (303) 423-4831

www.denverinstrument.com

European Office:
Denver Instrument Company, Ltd.
Denver House, Sovereign Way • Trafalgar Business Park
Downham Market, Norfolk PE38 9SW • England